

Telit

TRIZIUM®

Software User Guide

DAI Telecom S.p.a. 2003- 2004

Contents

1	OVERVIEW	5
2	BASIC OPERATIONS	6
2.1	Command Syntax.....	6
2.2	Command Response Timeout.....	6
2.3	Turning ON the TRIZIUM	9
2.4	Turning OFF the TRIZIUM	10
2.4.1	Software shutdown	10
2.4.2	Hardware shutdown	10
2.5	Hardware Unconditional Reboot	10
2.6	Checking device functionality	11
2.6.1	Autobauding	11
2.6.2	SIM presence checking.....	11
2.6.2.1	Enable the extended error result codes	11
2.6.2.2	Query SIM presence and status.....	12
2.6.2.3	Provide SIM PIN (only if required see point 2.6.2.2).....	12
2.6.2.4	Provide SIM PUK (only if required see par. 2.6.2.2).....	13
2.6.3	Network checking.....	13
2.6.3.1	Query network status	13
2.6.3.2	Network operator identification.....	15
2.6.3.3	Check for received signal strength & quality	16
2.6.3.4	Quick Network Status Checking.....	18
2.7	Placing a Voice call	20
2.7.1	Voice call device set up	20
2.7.1.1	Set the device in voice mode	20
2.7.1.2	Set the desired audio path active.....	20
2.7.1.3	Set the desired volume on the active audio path speaker output	21
2.7.1.4	Check for microphone mute setting	22
2.7.2	Phone number dialing	22
2.7.2.1	Dial a given phone number	22
2.7.3	Closing the voice call	23
2.7.3.1	Hang up the voice call	23
2.8	Placing a CSD Data call (not GPRS)	25
2.8.1	Data call device set up.....	25
2.8.1.1	Set the device in data mode.....	25
2.8.1.2	Set the desired modulation and speed for the connection.....	25
2.8.2	Phone number dialing (data call)	26
2.8.2.1	Dial a given phone number	26
2.8.3	Closing the Data call	27
2.8.3.1	Exit the data mode and enter the command mode.....	28
2.8.3.2	Hang up the data call	28
2.9	Answer an incoming Call	28
3	ADVANCED OPERATIONS.....	31
3.1	Accessing the phonebook.....	31
3.1.1	Preliminary phonebook set up	31

3.1.1.1	Selecting PB storage active	32
3.1.1.2	Enable Fixed Dialing Phonebook facility (only for FD PB)	34
3.1.2	Phonebook entry search by Name	34
3.1.3	Phonebook entry read by Index	36
3.1.4	Phonebook entry Write	37
3.1.5	Phonebook entry Delete	40
3.1.6	Phonebook entry Dial	41
3.2	Distinguish Calls	43
3.2.1	Identify the Call type	43
3.2.1.1	Set the extended incoming call indication	44
3.2.2	Identify the Caller	44
3.2.2.1	Set Caller line ID indication presentation	45
3.2.3	Restricting Calling Line Indication	45
3.2.3.1	CLIR Service status query	46
3.2.3.2	Restrict/Allow Caller line ID indication	46
3.3	Services and facilities handling	48
3.3.1	Pin Startup Request Control	48
3.3.1.1	PIN Request Service status query	48
3.3.1.2	Enable/Disable PIN request at Start-up	49
3.3.2	Call Waiting Indication Control	50
3.3.2.1	Enabling the Call Waiting indication	51
3.3.2.2	Disabling the Call Waiting indication	52
3.3.3	Call Divert Control	53
3.3.3.1	Call Diverting Service status query	54
3.3.3.2	Divert unconditionally the calls	56
3.3.3.3	Divert Missed Calls when mobile is Busy	58
3.3.3.4	Divert Missed Calls when mobile does not reply	59
3.3.3.5	Divert Missed Calls when mobile is not Reachable	60
3.3.3.6	Divert All Missed Calls	61
3.3.4	Call Barring Control	63
3.3.4.1	Call Barring Service status query	63
3.3.4.2	Barring/Unbarring All Incoming Calls	65
3.3.4.3	Barring/Unbarring Incoming Calls when in International Roaming	66
3.3.4.4	Barring/Unbarring All Outgoing Calls	67
3.3.4.5	Barring/Unbarring All Outgoing International Calls	68
3.3.4.6	Barring/Unbarring All Outgoing International Calls except to Home Country	69
3.3.4.7	Unbarring all the Calls	70
3.4	Power Saving function	71
3.4.1.1	Enabling/Disabling the power saving function	71
3.5	SMS handling	73
3.5.1	SMS device setup	73
3.5.1.1	Select SMS format type	73
3.5.1.2	Check SMS Service Centre number	74
3.5.1.3	Add SMS Service Centre number (only if required)	74
3.5.1.4	Select New Messages indication behavior	75
3.5.1.5	Set Text Mode Parameters (only in TEXT mode)	78
3.5.1.6	Select SMS Memory and check for memory space	84
3.5.2	IRA character set	85
3.5.3	Writing a New SMS to storage	86
3.5.4	Sending an SMS previously stored	87
3.5.5	Sending a new SMS without storing it	89
3.5.6	Deleting an SMS	90
3.5.7	Reading an SMS	91
3.5.8	Listing a group of SMSs	93
3.6	Using General Purpose Input/Output pins	96

3.6.1	GPIO pin setup	96
3.6.1.1	Setting GPIO pin as OUTPUT.....	96
3.6.1.2	Setting GPIO pin as INPUT.....	97
3.6.2	GPIO pin use	98
3.6.2.1	Querying GPIO pin status	98
3.6.2.2	Setting GPIO pin output status.....	100
3.6.2.3	Using GPIO6 pin as ALARM OUTPUT (alternate function).....	100
3.6.2.4	Using GPIO7 pin as BUZZER OUTPUT (alternate function).....	101
3.7	Clock/Alarm function	103
3.7.1	Clock date/time	103
3.7.1.1	Regulate the Clock.....	104
3.7.1.2	Read the current date/time.....	104
3.7.2	Alarm function	105
3.7.2.1	Regulate the Alarm time & behavior	105
3.7.2.2	Stop the Alarm activity	107
3.7.2.3	Querying the Alarm status.....	107
4	GPRS OPERATIONS.....	111
4.1	Introduction	111
4.1.1	CSD application example.....	113
4.1.2	GPRS application example	114
4.2	Preliminary GPRS context parameters setting	115
4.2.1	Context parameter setting.....	115
4.2.2	Minimum Quality of the Service Requested.....	116
4.2.3	Requested Quality of the Service	119
4.3	GPRS context activation and data state entering	120
4.4	GPRS data state exit	122
4.5	Easy GPRS - HTTP client application	123
4.6	Easy GPRS - EMAIL sending application	125
5	EASY CAMERA OPERATIONS.....	127
5.1	Easy Camera - Send photo via EMAIL	127
6	DOCUMENT CHANGE LOG.....	129

1 Overview

The purpose of this document is the description of some common AT command procedures that may be used with the [Telit TRIZIUM module](#).

In this document, all the basic functions of a mobile phone will be taken into account and for each one of them, a proper command sequence will be suggested.

In the Advanced operation section the more useful services and features of the GSM network supported by the [Telit TRIZIUM module](#) is taken into account and some command sequence and usage are provided for each one of them.

This document and its suggested command sequences shall not be considered mandatory; instead, the information given shall be used as a guide for properly using the [Telit module](#). For further commands and features that may not be explained in this document refer to the TRIZIUM Product Description document where all the supported AT commands are reported.

NOTE

The information presented in this document is believed to be accurate and reliable. However, no responsibility is assumed by DAI Telecom. for its use, nor any infringement of patents or other rights of third parties, which may result from its use. No license is granted by implication or otherwise under any patent rights of DAI Telecom other than for circuitry embodied in Telit products. This document is subject to change without notice.

2 Basic Operations

2.1 Command Syntax

In the next paragraphs the following notations are used:

- <cr> represents the Carriage Return Character (13)
- <lf> represents the Line Feed Character (10)
- <xx> represents a parameter whatever name is in place of the xx.(< and > characters are only for delimiting the parameter and **must not** be issued to the terminal).
- [<xx>] represents an optional parameter whatever name is in place of the xx. ([and] characters are only for delimiting the optional parameter and **must not** be issued to the terminal).

2.2 Command Response Timeout

Every command issued to the Telit TRIZIUM returns a result response if response codes are enabled (default) (see command ATQn). The time needed to process the given command and return the response varies from command to command and may depend also from the network on which the command may interact. As a result every command is provided with a proper timeout time, if this time elapses without any result from the operation, then the ERROR response is reported as if the operation was not successful.

The timeout time is quite short for commands that imply only internal set up commands, but may be very long for command that interact with the network (or even Networks).



***NOTE:** In case no response is received after the timeout time has been elapsed, then try repeating the last command and if still no response is received until the timeout time, then an Unconditional Shutdown MUST be issued and then the device shall be powered ON again.*

The default timeout is 100 ms for all the commands that have no interaction with the network. In the table below are listed all the commands whose timeout differs from the default 100 ms and their effective timeout:

Command	Timeout (Seconds)
ATH	20
AT+CBST	0.2
AT+CR	0.2
AT+CRC	0.2

AT+CRLP	0.2
AT+CSCS	0.2
AT+CEER	5
AT+CGMI	5
AT+CGMM	5
AT+CGMR	5
AT+CGSN	20
AT+CIMI	20
AT+CNUM	20
AT+CREG	5
AT+COPS	180
AT+CLCK	180
AT+CPWD	180
AT+CLIP	180
AT+CLIR	180
AT+CCFC	180
AT+CCWA	20
AT+CHLD	20
AT+CUSD	180
AT+CAOC	20
AT+CSSN	20
AT+CLCC	20
AT+CPAS	5
AT+CPIN	20
AT+CSQ	5
AT+CPBS	5
AT+CPBR	20
AT+CPBF	20
AT+CPBW	20
AT+CALM	5
AT+CRSL	5
AT+CLVL	5
AT+CMUT	5
AT+CACM	20
AT+CAMM	20
AT+CPUC	20
AT+CMEE	5
AT+VTS	20
AT+GMI	5
AT+GMM	5

AT+GMR	5
AT+GSN	20
ATI3	5
ATI4	5
ATI5	5
AT+CSMS	5
AT+CPMS	5
AT+CMGF	5
AT+CSCA	20
AT+CSMP	5
AT+CSDH	5
AT+CSAS	5
AT+CRES	5
AT+CNMI	5
AT#CAP	10
AT#SRS	10
AT#SRP	10
AT#STM	10
AT#PCT	10
AT#SHDN	10
AT#QTEMP	10
AT#SGPO	10
AT#GGPI	10
AT#MONI	10
+CGACT	180
+CGATT	180
+CGDATA	20
+CGDCONT	20
+CGPADDR	20
+CGREG	TBD
+CGQMIN	20
+CGQREQ	20

2.3 Turning ON the TRIZIUM

To turn on the TRIZIUM the pin ON# must be tied low for at least 1 second and then released.

A simple circuit to do it is:

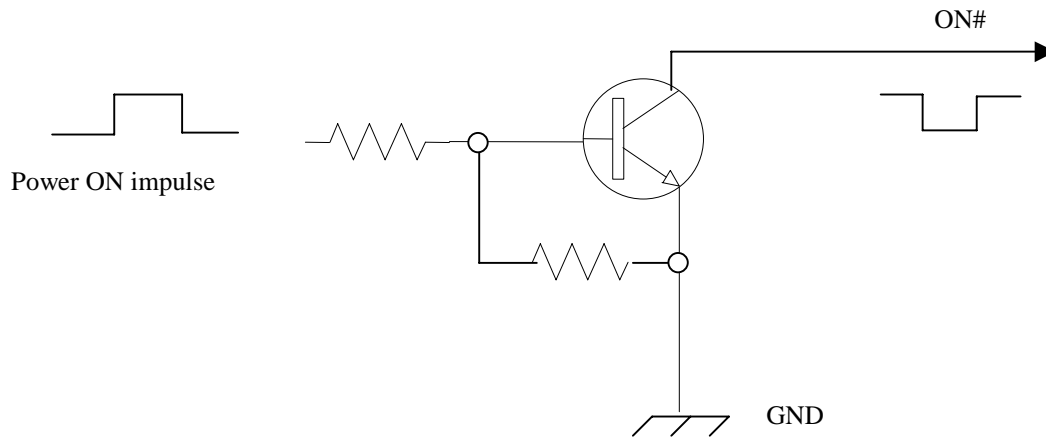

 **NOTE:** don't use any pull up resistor on the ON# line. Using pull up resistor may bring to latch up problems on the TRIZIUM power regulator and improper power off of the module. The line ON# must be connected only in open collector configuration.

 **TIP:** To check if power has raised it is possible to monitor the PWRCTL line, when this line goes high the module is powered on, but before it remains on the device needs other 900 ms for software startup. Hence check the PWRCTL line and 900 ms after its transition to high it is possible to release the ON# pin.

2.4 Turning OFF the TRIZIUM

The turning off of the device can be done in three ways:

- by software command
- by hardware shutdown

When the device is shut down by software command or by hardware shutdown, it issues to the network a detach request that informs the network that the device will not be reachable any more.

2.4.1 Software shutdown

- Send command **AT#SHDN<cr>**
- wait for **OK** response

The device shuts down immediately after the issue of the OK response.

2.4.2 Hardware shutdown

To turn OFF the TRIZIUM the pin ON# must be tied low for at least 1 second and then released.

The same circuitry for the power on can be used.

The device shuts down after the release of the ON# pin.





TIP: To check if the device has powered off, the hardware line PWRCTL should be monitored. When it goes low, the device has powered off.

2.5 Hardware Unconditional Reboot

To unconditionally Reboot the TRIZIUM the pin RESET# must be tied low for at least 200 milliseconds and then released.

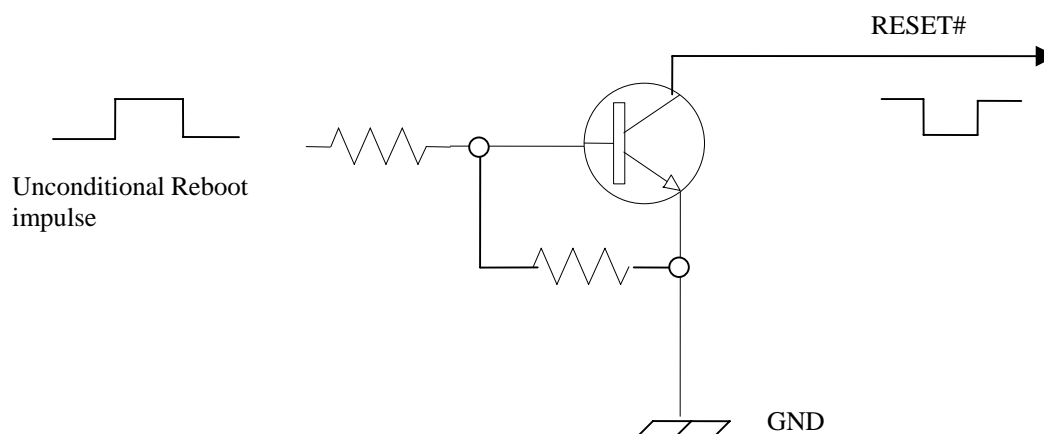
A simple circuit to do it is:



 **NOTE:** *don't use any pull up resistor on the RESET# line nor any totem pole digital output. Using pull up resistor may bring to latch up problems on the TRIZIUM power regulator and improper functioning of the module. The line RESET# must be connected only in open collector configuration.*

 **TIP:** *The unconditional hardware Reboot should be always implemented on the boards and software should use it as an emergency exit procedure.*

2.6 Checking device functionality

After a proper power on the device is ready to receive AT commands on the serial port.

Several things have to be checked in order to be sure that the device is ready to send and receive calls and SMS:

2.6.1 Autobauding

At startup it is necessary to send an AT command to make the device set the right speed and character format of the serial port. When this is done the device responds with OK. If no response is received within the timeout period of 200 ms retry.

- Send command **AT<cr>**
- wait for **OK** response

after this initial command, it is advisable to fix the port rate, in order to eliminate possible errors in detecting the serial speed rate:

- Send command **AT+IPR=<rate><cr>**
- wait for **OK** response

where rate is the port speed and can be 300,1200,2400,4800,9600,19200,38400,57600,115200 bps.

 **TIP:** *The serial port suggested setting is: port speed 38400, character format 8N1 (8 bit per char, No parity bit, 1 stop bit).*

2.6.2 SIM presence checking

After autobauding the first thing to check is the SIM presence and PIN code insertion, this can be done with the following commands:

2.6.2.1 Enable the extended error result codes

- send command **AT+CMEE=1<cr>**
- wait for **OK** response

or if you prefer the verbose format instead of the numerical format then:

- send command **AT+CMEE=2<cr>**
- wait for **OK** response

2.6.2.2 Query SIM presence and status

- send command **AT+CPIN<cr>**
- wait for response:

Response	Reason	Action
+CPIN: SIM PIN	SIM is present and PIN is required to continue operations	Proceed to par. 2.6.2.3
+CPIN: SIM PUK	SIM is present and 3 attempts to give SIM PIN have failed, so SIM PUK is required	Send command AT+CPIN=<SIM PUK>
+CPIN: READY	SIM is present and no PIN code is required to proceed	Proceed ahead
+CME ERROR: 10	SIM not present	Insert SIM or require SIM insertion and repeat from par. 2.6.2.2
+CME ERROR: 13	SIM defect	Check SIM insertion or require a new SIM not defected and repeat from par. 2.6.2.2
+CME ERROR: 14	SIM is busy	retry later
+CME ERROR: 15	SIM is wrong type	Check SIM, it must be a GSM SIM.

2.6.2.3 Provide SIM PIN (only if required see point 2.6.2.2)

- send command **AT+CPIN=****<cr>**

where **** stands for the SIM PIN code (e.g. 1234)

- wait for response:

Response	Reason	Action
OK	SIM PIN was correct	Proceed ahead
ERROR	the PIN code inserted is not correct	Retry from par. 2.6.2.2

 **NOTE:** When receiving the *ERROR* message, repeat Query SIM presence and status since after 3 failed attempts SIM PIN is not anymore requested, but SIM PUK is requested instead, hence you may need to go through procedure 2.6.2.4

2.6.2.4 Provide SIM PUK (only if required see par. 2.6.2.2)

- send command **AT+CPIN=*****<cr>**
where ***** stands for the SIM PUK code (e.g. 12345678)
- wait for response:

Response	Reason	Action
OK	SIM PUK was correct	Proceed ahead
ERROR	the SIM PUK code inserted is not correct	Retry from par. 2.6.2.4

 **TIP:** When receiving the *ERROR* message, be careful to check if the SIM PUK is correct before retrying, since after 10 failed attempts to provide the SIM PUK the SIM Card will lock and will not be usable anymore.

2.6.3 Network checking

2.6.3.1 Query network status

- send command **AT+CREG<cr>**
- wait for response:

Response	Reason	Action
----------	--------	--------

+CME ERROR: 10	SIM not present or damaged	Check SIM or require SIM insertion and repeat from par. 2.6.2.2
+CME ERROR: 11	SIM is present and PIN is required to continue operations	repeat par. 2.6.2.3
+CREG: 0,0 or +CREG: 1,0	No GSM/DCS network is found	Check for antenna cable connection (antenna may be disconnected or damaged) or change position if the antenna is OK. Repeat par. 2.6.3.1 until a network is found.
+CREG: 0,1 or +CREG: 1,1	Mobile is registered on its home network.	Proceed ahead. Ready to call
+CREG: 0,2 or +CREG: 1,2	Mobile is currently not registered on any network but is looking for a suitable one to register.	Repeat procedure at par. 2.6.3.1 to see if it has found a suitable network to register in.
+CREG: 0,3 or +CREG: 1,3	Mobile has found some networks but it is not allowed to register on any of them, no roaming was allowed.	Try in another place, and repeat procedure at par.2.6.3.1
+CREG: 0,4 or +CREG: 1,4	Mobile is in an unknown network status	Repeat procedure at par.2.6.3.1 to see if it has found a suitable network to register in
+CREG: 0,5 or +CREG: 1,5	Mobile has found some networks and is currently registered in roaming on one of them	Proceed ahead. Ready to call



TIP: When a response +CREG: x,1 or +CREG: x,5 is received, then the device is ready to place and receive a call or SMS. It is possible to jump directly to call setup procedures or SMS sending procedures.

2.6.3.2 Network operator identification

Once the mobile has registered on some network (or even if it has returned +CREG:x,3), it is possible to query the mobile for network identifications codes and names:

- send command **AT+COPS=?<cr>**
- wait for response in the format:
+COPS: (<STAT>,"<OP.NAME>", "", "<OP.CODE>")
+COPS: (<STAT>,"<OP.NAME>", "", "<OP.CODE>")
.....
OK

where:

<STAT> is a number representing the network operator status:

- 0 – UNKNOWN
- 1 – AVAILABLE
- 2 – CURRENTLY REGISTERED ON
- 3 – FORBIDDEN

<OP.NAME> is a string of 16 chars max with the alphanumeric code of the operator

<OP.CODE> is a five-digit number representing the code of the operator:

- first three digits: nation code
- last two digits: operator code

For example:

command:

AT+COPS=?<cr>

Answer:

+COPS: (2,"I TIM", "", "22201")

+COPS: (3,"I-OMNITEL", "", "22210")

+COPS: (1,"SI.MOBIL", "", "29340")

+COPS: (0,"SI-GSM", "", "29341")

OK

In this case the mobile is registered on the network "I TIM" which is a network from Italy Nation code :222 and Network ID: 01. There is also another network available for registration:

"SI.MOBIL" which is a network from Slovenia Nation Code:293 and Network ID: 40.

The other networks are not available for registration and are:

"I-OMNITEL" from Italy Nation code :222 and Network ID: 10 - FORBIDDEN

"SI-GSM " from Slovenia Nation Code:293 and Network ID: 41 - UNKNOWN



TIP: In this case a "I TIM" logo might be reproduced on the MMI to give the user the information that is registered on that network.



NOTE: this command issues a network request and it may require a quite long time to respond, since the device has to wait the answer from the network (it can be as long as 60 seconds). Hence don't use it if not needed.

2.6.3.3 Check for received signal strength & quality

Once the mobile has registered on one network, it may be useful to know the received signal strength & quality to give the user an indication of the reliability of the network.

- send command **AT+CSQ<cr>**
- wait for response in the format:
+CSQ: <rssi>,<ber>

OK

where:

<rssi> is an integer from 0 to 99 that indicates the received signal strength:

<rssi> value	Signal strength	Indication
0	-113 dBm or less	Signal is VERY low: at the extreme sensibility limit
1	-111 dBm	MMI may indicate only 1 antenna bar
2	-109 dBm	MMI may indicate only 1 antenna bar
3	-107 dBm	MMI may indicate only 1 antenna bar
4	-105 dBm	MMI may indicate only 1 antenna bar
5	-103 dBm	MMI may indicate only 1 antenna bar
6	-101 dBm	MMI may indicate 2 antenna bars
7	-99 dBm	MMI may indicate 2 antenna bars

8	-97 dBm	MMI may indicate 2 antenna bars
9	-95 dBm	MMI may indicate 2 antenna bars
10	-93 dBm	MMI may indicate 3 antenna bars
11	-91 dBm	MMI may indicate 3 antenna bars
12	-89 dBm	MMI may indicate 3 antenna bars
13	-87 dBm	MMI may indicate 3 antenna bars
14	-85 dBm	MMI may indicate 3 antenna bars
15	-83 dBm	MMI may indicate 4 antenna bars
16	-81 dBm	MMI may indicate 4 antenna bars
17	-79 dBm	MMI may indicate 4 antenna bars
18	-77 dBm	MMI may indicate 4 antenna bars
19	-75 dBm	MMI may indicate 4 antenna bars
20	-73 dBm	MMI may indicate 4 antenna bars
21	-71 dBm	MMI may indicate 4 antenna bars
22	-69 dBm	MMI may indicate 4 antenna bars
23	-67 dBm	MMI may indicate 4 antenna bars
24	-65 dBm	MMI may indicate 4 antenna bars
25	-63 dBm	MMI may indicate 4 antenna bars
26	-61 dBm	MMI may indicate 4 antenna bars
27	-59 dBm	MMI may indicate 4 antenna bars
28	-57 dBm	MMI may indicate 4 antenna bars
29	-55 dBm	MMI may indicate 4 antenna bars
30	-53 dBm	MMI may indicate 4 antenna bars
31	-51 dBm or more	MMI may indicate 4 antenna bars
99	not detected	MMI may indicate flashing antenna bars

 **NOTE:** when <rss> is less than 6, only 1 MMI antenna bar, the quality of a call will be poor and the call may even drop.

<ber> is an integer from 0 to 7 and 99 that reports the received signal quality measured on the radio traffic channel.

 **NOTE:** The quality is measured on the traffic channel, hence it is available only during a conversation, in Idle the reported value must not be considered.
In conversation the quality decreases with the increase of the <ber> number.

 *NOTE: The <ber> value refers strictly to the GSM radio channel and is a very technical parameter, it can be used to monitor the voice call quality since the voice quality is inversely proportional to the <ber> number.*

 *NOTE: For Data calls the signal quality reported is not directly connected to the connection quality. The reported signal quality refers only to the GSM radio channel link and not to the whole path from the caller to the receiver, so it may happen that the quality on the GSM radio link is very good and hence the reported <ber> is 0 (good quality) but the quality of the remaining path to the other party is very bad and hence the final data connection quality is very poor.*

For this reason the signal quality indicator <ber> should not be taken into account to monitor data calls quality.

2.6.3.4 Quick Network Status Checking

Once the mobile has registered on one network, it may be useful to know the received signal strength and the network on which the mobile is registered. These information can be gathered with the commands +CREG, +COPS and +CSQ, which are part of the standard ETSI GSM 07.07 commands as seen before, unfortunately these commands are not so fast in the response due to network response time, especially the +COPS command. If You want to keep your software as general as possible you can follow the indications given before and forget this part; instead if you need or want a faster way to check at the mobile network information, the TRIZIUM provides a special command **#MONI** which can be used to gather all the information needed in a faster and simpler way:

- send command **AT#MONI=0<cr>**
- wait for **OK** response

- send command **AT#MONI<cr>**
- wait for response in the format:

**#MONI: <netname> BSIC:<bsic> RxQual:<qual> LAC:<lac> Id:<id> ARFCN:<arfcn>
PWR:<dBm> dBm**

OK

or in the case the network name is not known:

**#MONI: Cc:<cc> Nc:<nc> BSIC:<bsic> RxQual:<qual> LAC:<lac> Id:<id>
ARFCN:<arfcn> PWR:<dBm> dBm**

OK

where:

<netname> = name of network operator

<cc> = country code

<nc> = network operator code

<n> = progressive number of adjacent cell

<bsic> = base station identification code

<qual> = quality of reception (0-7) (same as <ber> of +CSQ command)

<lac> = localization area code

<id> = cell identifier

<arfcn> = assigned radio frequency channel

<dBm> = received signal strength in dBm (same as "decoded" rssi value)

For example:

command:

```
AT#MONI=0<cr>
```

Answer:

```
OK
```

command:

```
AT#MONI<cr>
```

Answer:

```
#MONI: I TIM BSIC:23 RxQual:7 LAC:AEAD Id:5265 ARFCN: 59 PWR: -80 dBm
```

```
OK
```

In this case the mobile is registered on the network "I TIM", the signal strength is -80dBm (MMI may indicate 4 antenna bars as reported on the table 5). The other information received is strictly technical and should not be given to the user.

For example2:

command:

```
AT#MONI=0<cr>
```

Answer:

```
OK
```

command:

```
AT#MONI<cr>
```

Answer:

```
#MONI: Cc: 010 Nc: 03 BSIC:23 RxQual:7 LAC:0001 Id:0001 ARFCN: 60 PWR: -83 dBm
```

```
OK
```

In this case the mobile is registered on the network whose Country code is 010 and Network operator code is 03, the signal strength is -83dBm (MMI may indicate 4 antenna bars as reported on the table 5). The other information received is strictly technical and should not be given to the user. The values reported are random and have no meaning they are used only to explain command usage.

 **NOTE:** *This command should be used only to gather information on network name and signal strength, to check if mobile is registered or is looking for a suitable network to register to, use always the +CREG command. This is due to the fact that if the network signal is too weak and mobile loses the registration, until a new network is found the #MONI command reports the last measured valid values and not the real ones.*

 **TIP:** *To properly use this feature, check network registration with command +CREG as seen on par. 2.6.3.1 and when mobile is registered query the mobile for network operator name and signal strength with #MONI command.*

2.7 Placing a Voice call

Before a voice call can be placed, it is recommended to check if the mobile is registered on a network (see par. 2.6.3.1) and if the signal strength is enough to ensure a call can be made (see par. 2.6.3.3).

2.7.1 Voice call device set up

2.7.1.1 Set the device in voice mode

- Send command **AT+FCLASS=8<cr>**
- wait for **OK** response

NOTE: This command may be omitted if the modifier ";" is added at the end of the ATD command after the number to be dialed.

2.7.1.2 Set the desired audio path active

The TRIZIUM has two different audio paths:

- internal microphone/ear (MT)
- external microphone/ear (HF)

Usually the internal path is used for a handset function, while the external is used for handsfree function. There are two way to switch between these two paths:

- **SOFTWARE:** by using the command **AT#CAP= <n>** (with n=1 OR n=2)

- **HARDWARE**: by setting `AT#CAP=0` and setting the AXE input high (internal MT) or low (external HF).

If only one path is needed, then it is preferable to use the internal one (MT).



TIP: when Hardware control is not needed AXE pin can be left unconnected.



TIP: the audio paths can be switched also during a call in both ways.

- Send command **AT#CAP=<n><cr>**

where:

- <n> = 0 for **HARDWARE** control with AXE input
- <n> = 1 for external HF path (regardless of the AXE input status)
- <n> = 2 for internal MT path (regardless of the AXE input status)

- wait for **OK** response

For example:

1 - Let's assume that the desired audio path is always the internal MT

Command:

`AT#CAP=2<cr>`

Answer:

OK

2 - Let's assume that the desired audio path has to be determined by **HARDWARE** pin AXE

Command:

`AT#CAP=0<cr>`

Answer:

OK

Now set the hardware pin AXE in the desired status.

2.7.1.3 Set the desired volume on the active audio path speaker output

This setting is not strictly necessary; it is also possible to keep the default volume setting.

- Send command **AT+CLVL=<vol><cr>**

where:

<vol> is a number between 0 and 10 representing the volume setting:

- 0 – minimum volume
- 10 - maximum volume

- wait for **OK** response

 *NOTE: The volume setting refers to the ACTIVE path ear line and is stored each time. When changing audio path the volume setting will be reset to the previously stored value for that audio path.*

2.7.1.4 Check for microphone mute setting

The microphone of the active path can be muted with an AT command; to be sure that it is not muted, it is suggested to check it with this command:

- Send command **AT+CMUT?<cr>**
- wait for response in the format:
+CMUT: <mute>

OK

where:

<mute> is the muting setting for the microphone:

- 0 - microphone active
- 1 - microphone muted

 *NOTE: The mute setting is different from Volume setting: it refers to both the audio paths, the mute setting will remain even when changing audio path.*

2.7.2 Phone number dialing

2.7.2.1 Dial a given phone number

- Send command **ATD <PhoneNumber><cr>**

where:

<PhoneNumber> is the phone number to be dialed

- wait for response:

Response	Reason	Action
----------	--------	--------

OK	The call has been placed	Wait for the other party to lift the receiver..
BUSY	The line called is busy	retry later
NO ANSWER	The receiver did not answer the call	retry later
NO CARRIER	Call placing has not been successful	check for mobile registration and signal strength (par. 2.6.3)

For example:

1- Let's assume you have to call the national number 040 - 4192111,

command:

```
ATD 0404192111<cr>
```

response

OK

2- Let's assume you have to call the national number but in international format +39-40-4192111,

command:

```
ATD +39404192111<cr>
```

response

OK

3- Let's assume you have to call the international number +386-40-4192111 without previously setting the +FCLASS=8 (voice),

command:

```
ATD +386404192111;<cr>
```

response

OK

2.7.3 Closing the voice call

2.7.3.1 Hang up the voice call

- Send command **ATH<cr>**
- wait for response **OK**



TIP: during the voice call the device remains in command mode, so the escape sequence (+++) must not be issued before sending commands.

2.8 Placing a CSD Data call (not GPRS)

Before a data call can be placed, it is recommended to check if the mobile is registered on a network (see par. 2.6.3.1) and if the signal strength is enough to ensure that a call can be made (see par. 2.6.3.3).

2.8.1 Data call device set up

2.8.1.1 Set the device in data mode

- Send command **AT+FCLASS=0<cr>**
- wait for **OK** response



TIP: The +FCLASS setting is maintained in memory, so there's no need to repeat this command if +FCLASS setting is not changed.

2.8.1.2 Set the desired modulation and speed for the connection

The data connection can be made using different modulations at different speeds.

This connection mode can be selected with the command +CBST. The syntax for the command is:

AT+CBST=<mod>,0,<ce>

These parameters can be selected as seen in the table:

Command	Modulation	Speed [bps]	Connection Element
AT+CBST==0, 0, 1	Autobauding	----	non transparent
AT+CBST==1, 0, 1	V.21	300	non transparent
AT+CBST==2, 0, 1	V.22	1200	non transparent
AT+CBST==3, 0, 1	V.23	1200/75	non transparent
AT+CBST==4, 0, 1	V.22Bis	2400	non transparent
AT+CBST==6, 0, 1	V.32	4800	non transparent
AT+CBST==7, 0, 1	V.32	9600	non transparent
AT+CBST==14, 0, 1	V.34	14400	non transparent
AT+CBST==65, 0, 1	V.110	300	non transparent
AT+CBST==66, 0, 1	V.110	1200	non transparent
AT+CBST==68, 0, 1	V.110 / X.31	2400	non transparent

AT+CBST==70, 0, 1	V.110 / X.31	4800	non transparent
AT+CBST==71, 0, 1	V.110 / X.31	9600	non transparent
AT+CBST==75, 0, 1	V.110 / X.31	14400	non transparent
AT+CBST==1, 0, 0	V.21	300	transparent
AT+CBST==2, 0, 0	V.22	1200	transparent
AT+CBST==3, 0, 0	V.23	1200/75	transparent
AT+CBST==4, 0, 0	V.22Bis	2400	transparent
AT+CBST==6, 0, 0	V.32	4800	transparent
AT+CBST==7, 0, 0	V.32	9600	transparent
AT+CBST==65, 0, 0	V.110	300	transparent
AT+CBST==66, 0, 0	V.110	1200	transparent
AT+CBST==68, 0, 0	V.110 / X.31	2400	transparent
AT+CBST==70, 0, 0	V.110 / X.31	4800	transparent
AT+CBST==71, 0, 0	V.110 / X.31	9600	transparent

Once selected the appropriate <mod > and <ce> parameters from the table:

- Send command **AT+CBST=<mod>, 0, <ce><cr>**
- wait for **OK** response

2.8.2 Phone number dialing (data call)

2.8.2.1 Dial a given phone number

- Send command **ATD <PhoneNumber><cr>**

where:

<PhoneNumber> is the phone number to be dialed

- wait for response:

Response	Reason	Action
CONNECT 9600	The called modem is now on line.	exchange data..

BUSY	The line called is busy	retry later
NO ANSWER	The receiver did not answer the call	retry later
NO CARRIER	The modem handshaking has not been successful	check for mobile registration and signal strength (par. 2.6.3) and eventually retry.



TIP: The response to the ATD command is returned after the modem handshaking, this takes about 30 seconds, so allow this time before doing anything.



TIP: When the device is doing the handshake the issue of any character closes the handshake and aborts the call.

For example:

1- Let's assume you have to call the national number 040 - 4192111,

command:

ATD 0404192111<cr>

response

CONNECT 9600

2- Let's assume you have to call the national number but in international format +39-40-4192111,

command:

ATD +39404192111<cr>

response

CONNECT 9600

3- Let's assume you have to call the international number +386-40-4192111,

command:

ATD +386404192111<cr>

response

CONNECT 9600

2.8.3 Closing the Data call

2.8.3.1 Exit the data mode and enter the command mode

- Send escape sequence **+++**
- wait the escape sequence pause time (see S12 parameter)
- wait for response **OK**

 *NOTE: After the Escape sequence and during the call the only command that is accepted by the TRIZIUM is the ATH. All the other commands are not supported during a call.*

 *TIP: during the escape sequence pause time S12 no further characters should be sent to the device in order to enter the command mode.*

2.8.3.2 Hang up the data call

- Send command **ATH<cr>**
- wait for response **NO CARRIER**

 *TIP: during the data call the device remains in data (on line) mode, so the escape sequence (+++) must be issued before sending AT commands to the device.*

2.9 Answer an incoming Call

When an incoming call is detected the device reports an unsolicited code which may be:

Unsolicited code	Reason
RING	The extended format of incoming call indication is disabled and a call (voice or data) is incoming.
+CRING: VOICE	The extended format of incoming call indication is enabled and a voice call is incoming.
+CRING: ASYNC	The extended format of incoming call indication is enabled and an asynchronous transparent data call is incoming.

+CRING: REL ASYNC	The extended format of incoming call indication is enabled and an asynchronous reliable (not transparent) data call is incoming.
+CRING: SYNC	The extended format of incoming call indication is enabled and a synchronous transparent data call is incoming.
+CRING: REL SYNC	The extended format of incoming call indication is enabled and a synchronous reliable (not transparent) data call is incoming.
+CRING: FAX	The extended format of incoming call indication is enabled and a fax call is incoming.

To answer the call:

- Send command **ATA<cr>**
- wait for response:

Response	Reason	Action
CONNECT 9600	The incoming call was a DATA one and called modem is now on line.	exchange data..
ERROR	No incoming call is found, call may have been lost	call lost
NO CARRIER	The incoming call was a DATA one and the modem handshaking has not been successful	check for mobile registration and signal strength (par. 2.6.3) and modem settings.
OK	The incoming call was a VOICE call and is now active.	proceed ahead



TIP: The call is answered with the appropriate type (VOICE or DATA) regardless of the +FCLASS setting active. To distinguish between Data and Voice see the command response or the extended format incoming call indication.

3 Advanced Operations

3.1 Accessing the phonebook

The TRIZIUM can access the phonebook storage of the SIM card inserted, by using specific AT commands it is possible to store and recall phone numbers and their associated name.

3.1.1 Preliminary phonebook set up

The TRIZIUM supports several SIM phonebook storages:

- "SM" - SIM phonebook

This is the PB used to store and recall numbers during the normal operation of the device.

- "FD" - SIM fixed dialing-phonebook (only phase 2/2+ SIM)

This PB has several restrictions; to set it you need the PIN2 code and after having activated the FD only the calls to the numbers stored in the FD or their children are allowed, all the other calls are forbidden.

- "LD" - SIM last-dialing-list (+CPBW and +CPBF are not applicable for this storage)

This is the list of the last dialed numbers, it is updated automatically at each call originated and insertion or search on it is not possible, the only operations allowed are recall, read and delete.

- "MC" - SIM missed-calls-list (+CPBW and +CPBF are not applicable for this storage)

This is the list of the missed calls calling numbers, it is updated automatically at each call missed and insertion or search on it is not possible, the only operations allowed are recall, read and delete.

- "RC" - SIM received-calls-list (+CPBW and +CPBF are not applicable for this storage)

This is the list of the received calls calling numbers, it is updated automatically at each call received and insertion or search on it is not possible, the only operations allowed are recall, read and delete.

In order to access the storage you have to choose which one will be active. This must be the first PB operation always. Once selected storage, it is not anymore needed to select it again until the desired storage remains the one active and the device is not turned off.

3.1.1.1 Selecting PB storage active

- Send command **AT+CPBS=<PB><cr>**

where:

<PB> is the desired PB storage:

- SM – SIM phonebook
- FD – fixed dialing phonebook
- LD – last dialed calls list
- MC – missed calls list
- RC – received calls list

- wait for response:

Response	Reason	Action
OK	selected PB is now active	Proceed ahead
ERROR	some error occurred	Enable extended result codes (see par. 2.6.2.1) and retry.
+CME ERROR: 10	SIM not present	Check SIM or require SIM insertion and repeat from par. 2.6.2.2
+CMS ERROR: 310	SIM not present	Check SIM or require SIM insertion and repeat from par. 2.6.2.2
+CME ERROR: 11	SIM is present and PIN is required to continue operations	insert SIM PIN (see par. 2.6.2.3)
+CMS ERROR: 311	SIM is present and PIN is required to continue operations	insert SIM PIN (see par. 2.6.2.3)
+CME ERROR: 12	SIM is present and PUK is required to continue operations	insert SIM PUK (see par.2.6.2.4)
+CMS ERROR: 316	SIM is present and PUK is required to continue	insert SIM PUK (see par.2.6.2.4)

	operations	
+CME ERROR: 13	SIM defect	Check SIM insertion or require a new SIM not defected and repeat from par. 2.6.2.2
+CMS ERROR: 313	SIM defect	Check SIM insertion or require a new SIM not defected and repeat from par. 2.6.2.2
+CME ERROR: 14	SIM is busy	retry later
+CMS ERROR: 314	SIM is busy	retry later
+CME ERROR: 15	SIM is wrong type	Check SIM, it must be a GSM SIM.
+CMS ERROR: 315	SIM is wrong type	Check SIM, it must be a GSM SIM.
+CME ERROR: 17	PIN2 is required to continue operations, since FD facility is not enabled.	Enable FD facility with +CLCK (see par.3.1.1.2) and retry.

 *NOTE: After power up & PIN authentication the device reads all the SIM for a backup, hence SIM access is inhibited (SIM is busy after the issue of the PIN or after power up if PIN request is disabled) for a time varying from few seconds to about a minute, depending on the percentage of written records in the SIM phonebook. If Phonebook commands are issued during this time the device returns an error message. If this happens, retry the operations later.*

 *NOTE: Due to the particular features of the FD storage, when selecting the FD storage, the PIN2 must have been inserted or the FD facility must have been enabled.
If +CPBS command reports +CME ERROR: 17 then enable the facility with command +CLCK (see par. 3.1.1.2)*

For example:

1- Let's assume you want to select the "SM" normal phonebook for operations,

command:

AT+CPBS="SM"<cr>

response

OK

2- Let's assume you want to select the "MC" missed calls list for operations,

command:

`AT+CPBS="MC"<cr>`

response

OK

3.1.1.2 Enable Fixed Dialing Phonebook facility (only for FD PB)

- Send command `AT+CLCK=FD,1,<PIN2><cr>`

where:

<PIN2> is the PIN2 code of the SIM.

- wait for response:

Response	Reason	Action
OK	FD facility is now enabled	Return to select PB (see par. 3.1.1.1)
ERROR	some error occurred	Enable extended result codes (see par. 2.6.2.1), check if the PIN2 is correct and retry.
+CME ERROR: 16	the inserted PIN2 is wrong	Check PIN2 code and retry.

 **NOTE:** When receiving the *ERROR* or *+CME ERROR* message, repeat Query SIM presence and status since after 3 failed attempts SIM PIN2 is not anymore requested, but SIM PUK2 is requested instead, hence you may need to go through procedure 2.6.2.4 (but insert PUK2 instead of PUK1)

3.1.2 Phonebook entry search by Name

As first thing, you must select the "SM" storage as active (see par.3.1.1.1).

- send command `AT+CPBF=<Name><cr>`

where:

<Name> is the desired string to be found in the name field of the PB record.

- wait for response in the format:

+CPBF= <index>,"<number>",<type>,"<name>"

OK

where:

<index> is the record number on the PB;

<Number> is the phone number;

<type> is the type of number:

145 – international numbering scheme

129 – national numbering scheme

<Name> is the alphanumeric name associated with the number.

or in the case no corresponding entries are found:

+CME ERROR: 22 or simply **ERROR**.

 **NOTE:** *The search for <name> string is not case sensitive and the string may or may not be included in double brackets.*

For example:

1- Let's assume you want to select the "SM" normal phonebook for operations,

command:

AT+CPBS="SM"<cr>

response

OK

- Now you might want to look for the entries with the name starting with: "FA"

command:

AT+CPBF="FA"<cr>

the response may look like:

+CPBF= 7,"+39404192369",145,"Fabio"

+CPBF= 9,"0404192111",129,"Fabrizio"

OK

- Now you might want to look for the entries with the name starting with: "FAUSTO" but no record contains this name:

command:

AT+CPBF="FAUSTO"<cr>

response:

+CME ERROR: 22

or if extended error codes are disabled simply

response:

ERROR

3.1.3 Phonebook entry read by Index

As first thing, you must select the desired storage as active (see par.3.1.1.1). Then:

- send command **AT+CPBR=<index><cr>**

where:

<index> is the index number of the desired PB record to be read.

- wait for response in the format:

+CPBR= <index>,"<number>",<type>,"<name>"

OK

where:

<index> is the record number on the PB;

<Number> is the phone number;

<type> is the type of number:

145 – international numbering scheme

129 – national numbering scheme

<Name> is the alphanumeric name associated with the number.

or in the case the index number does not correspond to a written record:

+CME ERROR: 22 or simply **ERROR**.

For example:

1- Let's assume you want to select the "SM" normal phonebook for operations,

command:

```
AT+CPBS="SM"<cr>
```

response

OK

- Now you might want to look for the entry at the position index = 7

command:

```
AT+CPBR=7<cr>
```

the response may look like:

```
+CPBR= 7,"+39404192369",145,"Fabio"
```

OK

- Now you might want to look for the entries at the positions from 7 to 9 and for example the position at index 8 is empty

command:

```
AT+CPBR=7,9<cr>
```

the response may look like:

```
+CPBR= 7,"+39404192369",145,"Fabio"
```

```
+CPBR= 9,"0404192111",129,"Fabrizio"
```

OK

3.1.4 Phonebook entry Write

As first thing, you must select the desired storage as active (see par.3.1.1.1). Then:

- send command **AT+CPBW=<index> , <number> , <type> , <name><cr>**

where:

<index> is the index number of the desired PB record to be written (may be omitted if any empty record number can be used).

<Number> is the phone number;

<type> is the type of number:

- 145 – international numbering scheme (contains the character "+")
- 129 – national numbering scheme

<Name> is the alphanumeric name associated with the number.

- wait for response:

Response	Reason	Action
OK	Record has been successfully written	proceed ahead
ERROR	some error occurred	Enable extended result codes (see par. 2.6.2.1), and retry.
+CME ERROR: 10	SIM not present	Check SIM or require SIM insertion and repeat from par. 2.6.2.2
+CMS ERROR: 310	SIM not present	Check SIM or require SIM insertion and repeat from par. 2.6.2.2
+CME ERROR: 11	SIM is present and PIN is required to continue operations	insert SIM PIN (see par. 2.6.2.3)
+CMS ERROR: 311	SIM is present and PIN is required to continue operations	insert SIM PIN (see par. 2.6.2.3)
+CME ERROR: 12	SIM is present and PUK is required to continue operations	insert SIM PUK (see par.2.6.2.4)
+CMS ERROR: 316	SIM is present and PUK is required to continue operations	insert SIM PUK (see par.2.6.2.4)
+CME ERROR: 13	SIM defect	Check SIM insertion or require a new SIM not defected and repeat from par. 2.6.2.2
+CMS ERROR: 313	SIM defect	Check SIM insertion or

		require a new SIM not defected and repeat from par. 2.6.2.2
+CME ERROR: 14	SIM is busy	retry later
+CMS ERROR: 314	SIM is busy	retry later
+CME ERROR: 15	SIM is wrong type	Check SIM, it must be a GSM SIM.
+CMS ERROR: 315	SIM is wrong type	Check SIM, it must be a GSM SIM.
+CME ERROR: 21	invalid index	Change index number or leave it empty and retry.
+CME ERROR: 20	memory full	PB storage is full.
+CMS ERROR: 322	memory full	PB storage is full.

For example:

1- Let's assume you want to select the "SM" normal phonebook for operations,

command:

AT+CPBS="SM"<cr>

response

OK

- Now you might want to write a new record on the PB:

command:

AT+CPBW=,"0404192123",129,"NewRecord"<cr>

response:

OK

-Now you may want to check if operation has really succeeded and where the new record has been written. (obviously operation was successful, since the device returned OK)

command:

AT+CPBF="NEW"<cr>

response:

+CPBF= 8,"0404192123",129,"NewRecord"

OK

The new record was written at the position index 8. (The first free record index found).

3.1.5 Phonebook entry Delete

As first thing, the desired storage must be active (see par.3.1.1.1). Then:

- send command **AT+CPBW=<index><cr>**

where:

<index> is the index number of the desired PB record to be deleted.

- wait for response:

Response	Reason	Action
OK	Record has been successfully deleted	proceed ahead
ERROR	some error occurred	Enable extended result codes (see par. 2.6.2.1), and retry.
+CME ERROR: 21	invalid index, out of PB storage limits	check index number and retry.
+CME ERROR: 10	SIM not present	Check SIM or require SIM insertion and repeat from par. 2.6.2.2
+CMS ERROR: 310	SIM not present	Check SIM or require SIM insertion and repeat from par. 2.6.2.2
+CME ERROR: 11	SIM is present and PIN is required to continue operations	insert SIM PIN (see par. 2.6.2.3)
+CMS ERROR: 311	SIM is present and PIN is required to continue operations	insert SIM PIN (see par. 2.6.2.3)
+CME ERROR: 12	SIM is present and PUK is required to continue operations	insert SIM PUK (see par.2.6.2.4)
+CMS ERROR: 316	SIM is present and PUK is required to continue	insert SIM PUK (see par.2.6.2.4)

	operations	
+CME ERROR: 13	SIM defect	Check SIM insertion or require a new SIM not defected and repeat from par. 2.6.2.2
+CMS ERROR: 313	SIM defect	Check SIM insertion or require a new SIM not defected and repeat from par. 2.6.2.2
+CME ERROR: 14	SIM is busy	retry later
+CMS ERROR: 314	SIM is busy	retry later
+CME ERROR: 15	SIM is wrong type	Check SIM, it must be a GSM SIM.
+CMS ERROR: 315	SIM is wrong type	Check SIM, it must be a GSM SIM.



TIP: The delete operation simply overwrites the record number <index> with an empty record. If the record to be deleted was already empty, no error messages will be shown, but it will be only filled again with empty values.

3.1.6 Phonebook entry Dial

You may want to dial a number previously stored in the phonebook. As first thing, you must find the desired phone number index position, to do it use the +CPBF command. Once the <index> number is known set up the device for the type of call you want to dial. Then:

- send command **ATD> <index><cr>**

where:

<index> is the index number of the desired PB record to be dialed.

wait for response according to the call type you issued.

For example:

1- Let's assume you want to make a Voice call on the internal audio path MT to "Fabio" whose number is stored on the SIM PB:

- Select the PB as active storage

command:

```
AT+CPBS="SM"<cr>
```

response

OK

- Now find the index number where "Fabio" is recorded:

command:

```
AT+CPBF="Fabio"<cr>
```

the response may look like:

```
+CPBF= 7,"+39404192369",145,"Fabio"
```

OK

- the first field is the index position: 7 in this case.

- Now set up Voice call:

command:

```
AT+FCLASS=8<cr>
```

response:

OK

```
AT#CAP=2 <cr>
```

OK

```
AT+CLVL=8<cr>
```

OK

```
AT+CMUT? <cr>
```

```
+CMUT: 0
```

- and Dial:

```
ATD> 7<cr>
```

OK

3.2 Distinguish Calls

3.2.1 Identify the Call type

The TRIZIUM is able to identify the call type before answering it, it is so possible to have different ring indications (unsolicited codes) depending on the call type:

Unsolicited code	Reason
RING	The extended format of incoming call indication is disabled and a call (voice or data) is incoming.
+CRING: VOICE	The extended format of incoming call indication is enabled and a voice call is incoming.
+CRING: ASYNC	The extended format of incoming call indication is enabled and an asynchronous transparent data call is incoming.
+CRING: SYNC	The extended format of incoming call indication is enabled and a synchronous transparent data call is incoming.
+CRING: REL ASYNC	The extended format of incoming call indication is enabled and an asynchronous not transparent data call is incoming.
+CRING: REL SYNC	The extended format of incoming call indication is enabled and a synchronous not transparent data call is incoming.
+CRING: FAX	The extended format of incoming call indication is enabled and a fax call is incoming.

In order to use this feature you must enable the extended format of incoming calls

3.2.1.1 Set the extended incoming call indication

- Send command **AT+CRC=<n><cr>**

where:

<n> is the operation mode selected:

- 0 – extended results Disabled (device reports RING only)
- 1 – extended results Enabled (device reports +CRING: <type> indication)

- wait for **OK** response

3.2.2 Identify the Caller

The TRIZIUM is able to identify the caller number and give indication of it before the call is answered.

The calling number is presented after each RING or +CRING indication in the format:

+CLIP: "<number>",<type>["<subaddress>",<satype>["<alpha>"],["<CLI validity>"]]]

OK

where:

<Number> is the phone number;

<type> is the type of number:

- 145 – international numbering scheme
- 129 – national numbering scheme

<subaddress> is the subaddress of the calling party

<satype> is the type of subaddress

<alpha> is an optional string type alphanumeric representation of <number> corresponding to the entry found in phonebook;

<CLI validity> is the validity status of CLI presentation:

- 0 CLI valid.
- 1 CLI has been withheld by the originator.
- 2 CLI is not available due to interworking problems or limitation or originating network.

In order to use this feature you must enable the caller ID indication presentation, if feature is disabled then no CLI indication is given after the RING or +CRING code.

3.2.2.1 Set Caller line ID indication presentation

- Send command **AT+CLIP=<n><cr>**

where:

<n> is the operation mode selected:

- 0 – Calling Line Indication Presentation Disabled
- 1 – Calling Line Indication Presentation Enabled

- wait for **OK** response

For example:

1- Let's assume you receive a call from the national number 1234567890 and extended incoming calls indication is disabled while CLIP is enabled, you'll see:

ring indication:

RING

+CLIP: "1234567890",129

2- Let's assume you receive a call from the international number +391234567890 and extended incoming calls indication is disabled while CLIP is enabled, you'll see:

ring indication:

RING

+CLIP: "+391234567890",145

NOTE: this does not mean that the incoming call is an international one, it simply means that the numbering scheme used to identify the caller is the international one.

3.2.3 Restricting Calling Line Indication

The TRIZIUM is able to send the calling line indication (CLI) to the other party through the network when an outgoing call is made. This indication can be restricted (CLIR) in various ways:

- CLI sent always
- CLI never sent
- CLI temporary sent (normally not sent)
- CLI temporary not sent (normally sent)

3.2.3.1 CLIR Service status query

- send command **AT+CLIR?<cr>**
- wait for response in the format:

+CLIR: <n>,<m>

OK

where:

<n> is the facility status on the Mobile

- 0 – CLIR facility according to CLIR service network status
- 1 – CLIR facility active (CLI not sent)
- 2 – CLIR facility not active (CLI sent)

<m> is the facility status on the Network

- 0 - CLIR service not provisioned (service unavailable)
- 1 - CLIR service provisioned (service available)
- 2 - unknown (e.g. no network present, etc.)
- 3 - CLI temporary mode presentation restricted
- 4 - CLI temporary mode presentation allowed

 **NOTE:** *The <m> parameter reports the status of the service at network level.
If the CLIR service is not provisioned, then it is not possible to use this service and changing the first parameter <n> will not change the CLI presentation to the other party behavior of the network.*

For example:

1- Let's assume you want to check your CLIR settings:

command:

AT+CLIR? <cr>

response:

+CLIR: 2,4

In this case the CLIR service is temporary mode allowed on the network and the mobile sends the CLI when calling. (CLI Restriction not active).

3.2.3.2 Restrict/Allow Caller line ID indication

- Send command **AT+CLIR=<n><cr>**

where:

<n> is the operation mode selected:

- 0 – Calling Line Indication to the other party According to Network service status.
- 1 – Calling Line Indication Restriction Enabled (CLI not sent)
- 2 – Calling Line Indication Restriction Disabled (CLI sent)

- wait for **OK** response

For example:

1- Let's assume you want to disable the CLI presentation to the other party permanently:

command:

AT+CLIR=1<cr>

response:

OK

3.3 Services and facilities handling

The GSM standard provides several services and facilities for the user to handle the calls and the device security; the more useful facilities are:

- PIN request on Startup
- Call Diverting
- Call Barring

All this facility are supported by TRIZIUM and can be enabled or disabled, their status can be queried to the network (for call management) or to the device (startup PIN request).

3.3.1 Pin Startup Request Control

The device provides several security options, the principal one is the SIM PIN request at start up. If this option is active, after power up the device waits for the SIM PIN code insertion with command +CPIN (see par. 2.6.2.3). Until the right PIN code is inserted the device does not issue any operation that involves the network, for example it does not register on the network, it is not possible to receive and generate calls.

This security option can be enabled/disabled and its status can be queried.

3.3.1.1 PIN Request Service status query

- send command **AT+CLCK=SC,2<cr>**
- wait for response:

Response	Reason	Action
+CLCK: 0	PIN facility is disabled	Enable extended result codes (see par. 2.6.2.1), and retry.
+CLCK: 1	PIN facility is enabled	
ERROR	some error occurred	
+CME ERROR: 10	SIM not present	Check SIM or require SIM insertion and repeat from par. 2.6.2.2

+CMS ERROR: 310	SIM not present	Check SIM or require SIM insertion and repeat from par. 2.6.2.2
+CME ERROR: 11	SIM is present and PIN is required to continue operations	insert SIM PIN (see par. 2.6.2.3)
+CMS ERROR: 311	SIM is present and PIN is required to continue operations	insert SIM PIN (see par. 2.6.2.3)
+CME ERROR: 12	SIM is present and PUK is required to continue operations	insert SIM PUK (see par.2.6.2.4)
+CMS ERROR: 316	SIM is present and PUK is required to continue operations	insert SIM PUK (see par.2.6.2.4)
+CME ERROR: 13	SIM defect	Check SIM insertion or require a new SIM not defected and repeat from par. 2.6.2.2
+CMS ERROR: 313	SIM defect	Check SIM insertion or require a new SIM not defected and repeat from par. 2.6.2.2
+CME ERROR: 14	SIM is busy	retry later
+CMS ERROR: 314	SIM is busy	retry later
+CME ERROR: 15	SIM is wrong type	Check SIM, it must be a GSM SIM.
+CMS ERROR: 315	SIM is wrong type	Check SIM, it must be a GSM SIM.

3.3.1.2 Enable/Disable PIN request at Start-up

- Send command **AT+CLCK=SC, <n>, <PIN><cr>**

where:

<n> is the operation selected:

- 0 – Disable SIM PIN request at startup
- 1 – Enable SIM PIN request at startup

<PIN> is the SIM PIN code

- wait for **OK** response

For example:

1- Let's assume you want to disable the PIN request at startup and your PIN code is 1234:

command:

AT+CLCK=SC,0,1234<cr>

response:

OK

3.3.2 Call Waiting Indication Control

The call waiting service allows the mobile to receive an indication of an incoming call when a call is already active at the moment when the second call (third party) incomes; furthermore the third party receives a ringing indication as if the mobile was not busy instead of the busy tone.

This service is either managed at network level and at terminal level (local reporting).

 **NOTE:** *By disabling the call waiting indication on the network, the second call is not allowed and the third party receives immediately the busy tone. Enabling the local reporting in this situation of the call waiting may lead to undesired results because the terminal has to report something the network does not issue, hence when the service is disabled on the network it **MUST** be disabled also the local reporting. For this reason the commands `AT+CCWA=1,0,x` should be avoided.*

 **NOTE:** *Similarly in the opposite situation, when the call waiting service is enabled on the network, the local reporting should be active; else the third party receives a ring indication and awaits for response while the device does not issue any `+CCWA` unsolicited indication and will not know that the third party is waiting for response. For this reason the commands `AT+CCWA=0,1,x` should be avoided.*

The call waiting indication is in the format:

`+CCWA: "<number>",<type>,<class>`

where:

<Number> is the phone number;

<type> is the type of number:

- 145 – international numbering scheme
- 129 – national numbering scheme

<class> is a sum of integers representing the call type the service refers to:

- 1 – Voice calls
- 2 – Data calls
- 4 – Fax calls
- 5 – Voice + Fax calls
- 6 – Data + Fax calls
- 7 – Voice + Data + Fax calls

3.3.2.1 Enabling the Call Waiting indication

- send command **AT+CCWA=1,1,<class><cr>**

where:

<class> is a sum of integers representing the call type the service refers to:

- 1 – Voice calls
- 2 – Data calls
- 4 – Fax calls
- 5 – Voice + Fax calls
- 6 – Data + Fax calls
- 7 – Voice + Data + Fax calls

- wait for response:

Response	Reason	Action
OK	The call waiting indication is now active	
ERROR	some error occurred	Enable extended result codes (see par. 2.6.2.1), and retry.
+CME ERROR: 4	operation not supported	Check command syntax and that the service is supported by your network operator and retry.

For example:

1- Let's assume you want to enable the call waiting indication for the Voice Calls:

command:

`AT+CCWA=1,1,1<cr>`

response:

OK

Now the call waiting indication is active, if a Voice call will income during another call you will receive the unsolicited indication:

+CCWA: "PhoneNumber", TypeOfNumber, ClassOfCall

For example the third party that calls has the number +391234567890 and issues a Voice call:

+CCWA: "+391234567890",145,1

3.3.2.2 Disabling the Call Waiting indication

- send command `AT+CCWA=0,0,<class><cr>`

where:

<class> is a sum of integers representing the call type the service refers to:

- 1 – Voice calls
- 2 – Data calls
- 4 – Fax calls
- 5 – Voice + Fax calls
- 6 – Data + Fax calls
- 7 – Voice + Data + Fax calls

- wait for response:

Response	Reason	Action
OK	The call waiting indication is now disabled	
ERROR	some error occurred	Enable extended result codes (see par. 2.6.2.1), and retry.

+CME ERROR: 4	operation not supported	Check command syntax and that the service is supported by your network operator and retry.
---------------	-------------------------	--

For example:

1- Let's assume you want to disable the call waiting indication for all the type of Calls:

command:

AT+CCWA=0,0,7<cr>

response:

OK

3.3.3 Call Divert Control

The call divert service allows the network operator to divert the incoming calls to another phone number in various cases:

- when the mobile is not reachable (turned off or in a place with no field)
- when the mobile is busy in another call
- when the mobile does not answer the call
- always (unconditional)
- all calls divert (NO QUERY COMMAND IS ALLOWED)
- all conditional diverting (NO QUERY COMMAND IS ALLOWED)



NOTE: The All calls divert and All conditional diverting types are only for Enable/Disable, Register/Erase, the Query command is not allowed with these types of diverting.



NOTE: The difference between the unconditional diverting and All calls divert is that while the unconditional diverting overrides the other conditional diverting without changing their setting registered on the network, the All calls diverting changes all the network setting for all the conditional ones. For this reason if a busy divert to 1234 is registered and an unconditional divert to 5678 is registered and then removed the busy divert returns to its previous number 1234; in the same condition if an All calls divert to 5678 is registered and then erased, the result is that the busy divert will be changed into 5678 (All call register) and then erased (all call erase).



NOTE: On The call Diverting service is possible to Enable/Disable the service instead of Register and erase it. The difference is that in the first case the divert information (number where the call is diverted and condition) is maintained by the network even if the divert is not active (calls arrive to Mobile) in order to achieve a faster enabling, while in the second case the information is completely canceled.

When a call Divert has been only Disabled the query for its status reports the network stored data as if the call divert would be active, causing a bit of confusion.

For this reason, it is suggested to use only the register and erase commands as explained in the next paragraphs; Disable/Enable features should be avoided.

 **NOTE:** *The call Diverting service is handled by the network, hence all the relative commands issue a network request and it may take several seconds to have the response from the network.*

Furthermore all the Diverting service commands must be issued when the mobile is Registered on some Network, else an error code is returned (no network service).

 **NOTE:** *The call Diverting service is handled by the network and the different types of diverting should be considered as standalone services. Hence the "unconditional diverting" is not the sum of the mobile busy+no reply+not reachable diverting service. If only the unconditional diverting has been registered, then the only service that can be erased is the unconditional diverting.*

3.3.3.1 Call Diverting Service status query

- send command **AT+CCFC=<fac> , 2<cr>**

where:

<fac> is the facility to be queried:

- 0 – unconditional diverting
- 1 - mobile busy diverting
- 2 - no reply diverting
- 3 - not reachable diverting
- 4 - all calls diverting (**QUERY NOT ALLOWED**)
- 5 - all conditional calls diverting (**QUERY NOT ALLOWED**)

- wait for response in the format:

+CCFC: <status>,<class>[,<number>[,<type>[,,, dopo <time>s]]]

OK

where:

<status> is the facility status

- 0 – facility not active (call not diverted)
- 1 – facility active (call diverted)

<class> is a sum of integers representing the call type the service refers to:

- 1 – Voice calls
- 2 – Data calls
- 4 – Fax calls
- 5 – Voice + Fax calls
- 6 – Data + Fax calls
- 7 – Voice + Data + Fax calls

<number> is the (optional) number where the call is being diverted:

<type> is the (optional) number type where the call is being diverted:

- 145 – international numbering scheme
- 129 – national numbering scheme

<time> is the (optional) time in seconds (1-30) after which the call is diverted for the "no reply" divert case.

Response	Reason	Action
+CCFC: 0,x	facility is disabled	
+CCFC: 1,x,x,x	facility is enabled	
+CME ERROR: 4	operation not supported, the service required is not available	Check command syntax and service code
+CME ERROR: 30	no network service	Check for registration (see par. 2.6.3.1) and signal strength.

For example:

1- Let's assume you want to check whether the incoming calls made when the mobile is not reachable are diverted or not:

command:

AT+CCFC=3,2<cr>

response:

+CCFC: 0,7

In this case, all the incoming calls ARE NOT DIVERTED when the mobile is not reachable.

The <class>=7 means that the status reported refers to: 1(voice)+2(data)+4(fax) type calls.

2- Let's assume you want to check whether the incoming calls made when the mobile is busy are diverted or not:

command:

```
AT+CCFC=1,2<cr>
```

response:

```
+CCFC: 1,1,+391234567890,145
```

```
+CCFC: 1,4,04012345678,129
```

OK

In this case the incoming VOICE (<class>=1) calls when mobile is busy are diverted to the number expressed in international format (<type>=145) +391234567890; the incoming FAX (<class>=4) calls when mobile is busy are diverted to the number expressed in national format (<type>=129) 04012345678; the DATA calls (<type>=2) are not diverted.

3- Let's assume you want to check whether the incoming calls with no reply are diverted or not:

command:

```
AT+CCFC=2,2<cr>
```

response:

```
+CCFC: 1,1,+391234567890,145,,,dopo 20s
```

```
+CCFC: 1,6,04012345678,129,,,dopo5s
```

OK

In this case the incoming VOICE (<class>=1) calls after 20 seconds of ringing are diverted (no reply) to the number expressed in international format (<type>=145) +391234567890; the incoming DATA and FAX (<class>=2 + 4) calls after 5 seconds of ringing are diverted to the number expressed in national format (<type>=129) 04012345678.

3.3.3.2 Divert unconditionally the calls

- Send command **AT+CCFC=0,3,<number>,<type>,<class><cr>**

where:

<number> is the desired number where the calls shall be redirected

<type> is the number type where the call is being diverted:

145 – international numbering scheme (number begins with "+")

129 – national numbering scheme

<class> is a sum of integers representing the call type the service refers to:

- 1 – Voice calls
- 2 – Data calls
- 4 – Fax calls
- 5 – Voice + Fax calls
- 6 – Data + Fax calls
- 7 – Voice + Data + Fax calls

- wait for response:

Response	Reason	Action
OK	diverting is now active	calls will be redirected
ERROR	some error occurred	Enable the extended error codes report (see par.2.6.2.1) and retry.
+CME ERROR: 4	operation not supported, the service required is not available	Check command syntax and service code
+CME ERROR: 30	no network service	Check for registration (see par. 2.6.3.1) and signal strength.

For example:

1- Let's assume you want to divert all the calls unconditionally to the national number 1234567890:

command:

AT+CCFC=0,3,1234567890,129,7<cr>

response:

OK

1- Let's assume you want to divert all the VOICE calls unconditionally to the international number +391234567890:

command:

AT+CCFC=0,3,+391234567890,145,1<cr>

response:

OK

3.3.3.3 Divert Missed Calls when mobile is Busy

- Send command **AT+CCFC=1,3,<number>,<type>,<class><cr>**

where:

<number> is the desired number where the calls shall be redirected

<type> is the number type where the call is being diverted:

- 145 – international numbering scheme (number begins with "+")
- 129 – national numbering scheme

<class> is a sum of integers representing the call type the service refers to:

- 1 – Voice calls
- 2 – Data calls
- 4 – Fax calls
- 5 – Voice + Fax calls
- 6 – Data + Fax calls
- 7 – Voice + Data + Fax calls

- wait for response:

Response	Reason	Action
OK	diverting is now active	calls will be redirected
ERROR	some error occurred	Enable the extended error codes report (see par.2.6.2.1) and retry.
+CME ERROR: 4	operation not supported, the service required is not available	Check command syntax and service code
+CME ERROR: 30	no network service	Check for registration (see par. 2.6.3.1) and signal strength.

For example:

1- Let's assume you want to divert all the calls lost because the mobile is busy to the national number 1234567890:

command:

AT+CCFC=1,3,1234567890,129,7<cr>

response:

OK

1- Let's assume you want to divert all the VOICE calls lost because the mobile is busy to the international number +391234567890:

command:

AT+CCFC=1,3,+391234567890,145,1<cr>

response:

OK

3.3.3.4 Divert Missed Calls when mobile does not reply

- Send command **AT+CCFC=2,3,<number>,<type>,<class><cr>**

where:

<number> is the desired number where the calls shall be redirected

<type> is the number type where the call is being diverted:

145 – international numbering scheme (number begins with "+")

129 – national numbering scheme

<class> is a sum of integers representing the call type the service refers to:

1 – Voice calls

2 – Data calls

4 – Fax calls

5 – Voice + Fax calls

6 – Data + Fax calls

7 – Voice + Data + Fax calls

- wait for response:

Response	Reason	Action
OK	diverting is now active	calls will be redirected
ERROR	some error occurred	Enable the extended error codes report (see par.2.6.2.1) and retry.

+CME ERROR: 4	operation not supported, the service required is not available	Check command syntax and service code
+CME ERROR: 30	no network service	Check for registration (see par. 2.6.3.1) and signal strength.

For example:

1- Let's assume you want to divert all the calls lost because the mobile does not reply, to the national number 1234567890:

command:

`AT+CCFC=2,3,1234567890,129,7<cr>`

response:

OK

1- Let's assume you want to divert all the VOICE calls lost because the mobile does not reply, to the international number +391234567890:

command:

`AT+CCFC=2,3,+391234567890,145,1<cr>`

response:

OK

3.3.3.5 Divert Missed Calls when mobile is not Reachable

- Send command `AT+CCFC=3,3,<number>,<type>,<class><cr>`

where:

<number> is the desired number where the calls shall be redirected

<type> is the number type where the call is being diverted:

- 145 – international numbering scheme (number begins with "+")
- 129 – national numbering scheme

<class> is a sum of integers representing the call type the service refers to:

- 1 – Voice calls
- 2 – Data calls
- 4 – Fax calls
- 5 – Voice + Fax calls

- 6 – Data + Fax calls
- 7 – Voice + Data + Fax calls

- wait for response:

Response	Reason	Action
OK	diverting is now active	calls will be redirected
ERROR	some error occurred	Enable the extended error codes report (see par.2.6.2.1) and retry.
+CME ERROR: 4	operation not supported, the service required is not available	Check command syntax and service code
+CME ERROR: 30	no network service	Check for registration (see par. 2.6.3.1) and signal strength.

For example:

1- Let's assume you want to divert all the calls lost because the mobile is not reachable, to the national number 1234567890:

command:

`AT+CCFC=3,3,1234567890,129,7<cr>`

response:

OK

1- Let's assume you want to divert all the VOICE calls lost because the mobile is not reachable, to the international number +391234567890:

command:

`AT+CCFC=3,3,+391234567890,145,1<cr>`

response:

OK

3.3.3.6 Divert All Missed Calls

- Send command `AT+CCFC=5,3,<number>,<type>,<class><cr>`

where:

<number> is the desired number where the calls shall be redirected

<type> is the number type where the call is being diverted:

- 145 – international numbering scheme (number begins with "+")
- 129 – national numbering scheme

<class> is a sum of integers representing the call type the service refers to:

- 1 – Voice calls
- 2 – Data calls
- 4 – Fax calls
- 5 – Voice + Fax calls
- 6 – Data + Fax calls
- 7 – Voice + Data + Fax calls

- wait for response:

Response	Reason	Action
OK	diverting is now active	calls will be redirected
ERROR	some error occurred	Enable the extended error codes report (see par.2.6.2.1) and retry.
+CME ERROR: 4	operation not supported, the service required is not available	Check command syntax and service code
+CME ERROR: 30	no network service	Check for registration (see par. 2.6.3.1) and signal strength.

For example:

1- Let's assume you want to divert all the calls lost, to the national number 1234567890:

command:

AT+CCFC=5,3,1234567890,129,7<cr>

response:

OK

1- Let's assume you want to divert all the VOICE calls lost, to the international number

+391234567890:

command:

AT+CCFC=5,3,+391234567890,145,1<cr>

response:

OK

3.3.4 Call Barring Control

The call Barring is a GSM service that allows the user to block certain types of calls:

- Barring All Outgoing Calls
- Barring Outgoing International Calls
- Barring Outgoing International Calls except to Home Country
- Barring All Incoming Calls
- Barring Incoming Calls when Roaming outside the home country
- All Barring services (applicable only for disabling command)
- All Outgoing barring services (applicable only for disabling command)
- All Incoming barring services (applicable only for disabling command)

The service can be queried, enabled and disabled.

 **NOTE:** *The call Barring service is handled by the network, hence all the relative commands issue a network request and it may take several seconds to have the response from the network.*

Furthermore, all the Call Barring service commands must be issued when the mobile is Registered on some Network, else an error code is returned (no network service).

3.3.4.1 Call Barring Service status query

- send command **AT+CLCK=<fac> , 2<cr>**

where:

<fac> is the facility to be queried:

AO - Barring All Outgoing Calls

OI - Barring Outgoing International Calls

OX- Barring Outgoing International Calls except to Home Country

AI - Barring All Incoming Calls

IR - Barring Incoming Calls when Roaming outside the home country

- AB - All Barring services (applicable only for disabling command)
- AG - All Outgoing barring services (applicable only for disabling command)
- AC - All Incoming barring services (applicable only for disabling command)

- wait for response:

Response	Reason	Action
+CLCK: 0	facility is disabled	calls are allowed
+CLCK: 1	facility is enabled	calls are barred
+CME ERROR: 4	operation not supported, the service required is not available	Check command syntax and service code
+CME ERROR: 30	no network service	Check for registration (see par. 2.6.3.1) and signal strength.

 **NOTE:** *The call Barring service is handled by the network, hence all the relative commands issue a network request and it may take several seconds to have the response from the network. Furthermore all the Barring service commands must be issued when the mobile is Registered on some Network, else an error code is returned (no network service).*

For example:

1- Let's assume you want to check whether the incoming calls when roaming outside Home Country are barred or not:

command:

AT+CLCK=IR,2<cr>

response:

+CLCK: 0

In this case, the incoming (received) calls ARE NOT BARRED when in Roaming outside the Home Country.

2- Let's assume you want to check whether the Outgoing (originated) international calls are barred or not:

command:

AT+CLCK=OI,2<cr>

response:

+CLCK: 1

In this case, the outgoing international calls ARE BARRED.

3.3.4.2 Barring/Unbarring All Incoming Calls

- Send command **AT+CLCK=AI , <en> , <pwd><cr>**

where:

<en> is the operation selected:

- 0 – Call Barring Disable (Unbarring)
- 1 – Call Barring Enable (Barring)

<pwd> is the network password required to change facility status

- wait for response:

Response	Reason	Action
OK	Barring is now enabled/disabled	all incoming calls will be barred/unbarred
ERROR	some error occurred	Enable the extended error codes report (see par.2.6.2.1) and retry.
+CME ERROR: 4	operation not supported, the service required is not available	Check command syntax
+CME ERROR: 30	no network service	Check for registration (see par. 2.6.3.1) and signal strength.
+CME ERROR: 16	wrong network password	check network password and retry

For example:

1- Let's assume you want to bar all the incoming calls and the network password of your operator is 0000:

command:

AT+CLCK=AI,1,0000<cr>

response:

OK

3.3.4.3 Barring/Unbarring Incoming Calls when in International Roaming

- Send command **AT+CLCK=IR,<en>,<pwd><cr>**

where:

<en> is the operation selected:

- 0 – Call Barring Disable (Unbarring)
- 1 – Call Barring Enable (Barring)

<pwd> is the network password required to change facility status

- wait for response:

Response	Reason	Action
OK	Barring is now enabled/disabled	all incoming calls when is international Roaming will be barred/unbarred
ERROR	some error occurred	Enable the extended error codes report (see par.2.6.2.1) and retry.
+CME ERROR: 4	operation not supported, the service required is not available	Check command syntax
+CME ERROR: 30	no network service	Check for registration (see par. 2.6.3.1) and signal strength.
+CME ERROR: 16	wrong network password	check network password and retry

For example:

1- Let's assume you want to bar all the incoming calls when the mobile is roaming outside its home country and the network password of your operator is 0000:

command:

AT+CLCK=IR,1,0000<cr>

response:

OK

3.3.4.4 Barring/Unbarring All Outgoing Calls

- Send command **AT+CLCK=AO, <en>, <pwd><cr>**

where:

<en> is the operation selected:

- 0 – Call Barring Disable (Unbarring)
- 1 – Call Barring Enable (Barring)

<pwd> is the network password required to change facility status

- wait for response:

Response	Reason	Action
OK	Barring is now enabled/disabled	all outgoing calls will be barred/unbarred
ERROR	some error occurred	Enable the extended error codes report (see par.2.6.2.1) and retry.
+CME ERROR: 4	operation not supported, the service required is not available	Check command syntax
+CME ERROR: 30	no network service	Check for registration (see par. 2.6.3.1) and signal strength.
+CME ERROR: 16	wrong network password	check network password and retry

For example:

1- Let's assume you want to bar all the outgoing calls (originated by mobile) and the network password of your operator is 0000:

command:

AT+CLCK=AO,1,0000<cr>

response:

OK

3.3.4.5 Barring/Unbarring All Outgoing International Calls

- Send command **AT+CLCK=OI , <en> , <pwd><cr>**

where:

<en> is the operation selected:

- 0 – Call Barring Disable (Unbarring)
- 1 – Call Barring Enable (Barring)

<pwd> is the network password required to change facility status

- wait for response:

Response	Reason	Action
OK	Barring is now enabled/disabled	all outgoing international calls will be barred/unbarred
ERROR	some error occurred	Enable the extended error codes report (see par.2.6.2.1) and retry.
+CME ERROR: 4	operation not supported, the service required is not available	Check command syntax
+CME ERROR: 30	no network service	Check for registration (see par. 2.6.3.1) and signal strength.
+CME ERROR: 16	wrong network password	check network password and retry

For example:

1- Let's assume you want to bar all the outgoing international calls (originated by mobile and to a number outside the home country of the mobile) and the network password of your operator is 1234:

command:

AT+CLCK=OI,1,1234<cr>

response:

OK

3.3.4.6 Barring/Unbarring All Outgoing International Calls except to Home Country

- Send command **AT+CLCK=OX, <en>, <pwd><cr>**

where:

<en> is the operation selected:

- 0 – Call Barring Disable (Unbarring)
- 1 – Call Barring Enable (Barring)

<pwd> is the network password required to change facility status

- wait for response:

Response	Reason	Action
OK	Barring is now enabled/disabled	all outgoing international calls except to Home Country will be barred/unbarred
ERROR	some error occurred	Enable the extended error codes report (see par.2.6.2.1) and retry.
+CME ERROR: 4	operation not supported, the service required is not available	Check command syntax
+CME ERROR: 30	no network service	Check for registration (see par. 2.6.3.1) and signal strength.
+CME ERROR: 16	wrong network password	check network password and retry

For example:

1- Let's assume you want to bar all the outgoing international calls except the ones towards the Home Country and the network password of your operator is 1234:

command:

AT+CLCK=OX,1,1234<cr>

response:

OK

3.3.4.7 Unbarring all the Calls

- Send command **AT+CLCK=AB,0,<pwd><cr>**

where:

<pwd> is the network password required to change facility status

- wait for response:

Response	Reason	Action
OK	Barring is now disabled	all calls will be allowed (unbarred)
ERROR	some error occurred	Enable the extended error codes report (see par.2.6.2.1) and retry.
+CME ERROR: 4	operation not supported, the service required is not available	Check command syntax
+CME ERROR: 30	no network service	Check for registration (see par. 2.6.3.1) and signal strength.
+CME ERROR: 16	wrong network password	check network password and retry

For example:

1- Let's assume you want to disable all the barring services you might have previously activated and the network password of your operator is 0000:

command:

AT+CLCK=AB,0,0000<cr>

response:

OK

3.4 Power Saving function

The Telit TRIZIUM has a special function that reduces the power consumption during the idle time, thus allowing a longer standby time with a given battery capacity.

This function monitors the DTR line indicating that the OEM application is ready to send commands, when it goes high (3V on UART) then the OEM application is not going to send any commands and the TRIZIUM module can save energy by shutting down its internal serial port.

When the OEM application becomes again ready, then the line DTR is tied low (0V on UART); the TRIZIUM detects this condition and powers up the serial port.

If the power saving function is activated, then the serial port must support the DTR line since when this line is high (Data Terminal is NOT ready) the device goes into a sleep condition and will not respond to commands until the DTR is tied low (Data Terminal is ready).

 **NOTE:** *The power saving function does not affect the network behavior of the TRIZIUM, even during the power save condition the module remains registered on the network and reachable for incoming calls or SMS. If a call income during the power save, then the module will wake up and proceed normally with the unsolicited incoming call code.*

 **TIP:** *When the TRIZIUM wakes up from the sleep mode, it takes a maximum of 150 milliseconds before it can exchange commands on the serial port. Hence place a delay of at least 150 ms between the port opening (DTR lowering) and command sending.*

According to the V24 standard, when the module is not ready to receive commands it will tie up the CTS line, while it will pull it down when it's ready to receive commands; hence you can monitor the CTS line to ensure the TRIZIUM is ready for commands.

3.4.1.1 Enabling/Disabling the power saving function

- send command **AT+CFUN=<fun><cr>**

where:

<fun> is the power saving function mode, the supported values are:

- 1 – Mobile full functionality with power saving disabled (default)
- 5 – Mobile full functionality with power saving enabled

- wait for response:

Response	Reason	Action
OK	The power save is now active	
ERROR	some error occurred	Enable extended result codes (see par. 2.6.2.1), and retry.
+CME ERROR: 4	operation not supported	Check command syntax and <fun> value.



TIP: The power saving function is disabled by default when the device starts up, in order to guarantee that even without the DTR line support it is possible to exchange commands with the module; for this reason the power saving setting command shall be issued after every power up.

3.5 SMS handling

The Telit TRIZIUM supports the Short Message Service, it is possible to store, delete, write, send and receive a SMS, which is a short text message up to 160 characters long.

3.5.1 SMS device setup

Before accessing the Short Message Service, the device has to be properly set up.

3.5.1.1 Select SMS format type.

The TRIZIUM supports SMS in two different formats:

- PDU
- Text

The difference is that in the PDU mode the device returns and receives SMS encoded in the format ready to be sent to the network; in TEXT mode the device converts automatically the read PDU into text and viceversa. By using TEXT mode the PDU data encoding knowledge is not needed and operations are easier. For this reason, we will use the TEXT mode to explain how to operate with SMS. If you are familiar with PDU encoding then you can operate with PDU by selecting that format and using appropriate command syntax.

- Send command **AT+CMGF=<mode><cr>**

where:

<mode> is the SMS format type:

- 0 – PDU
- 1 – Text

- wait for response **OK**



TIP: This setting is stored and remains until the device is turned off. Hence, there's no need to issue it more than one time. For TEXT mode use <mode>=1.

For example:

1- Let's assume you want to set TEXT format for the SMS:

command:

AT+CMGF=1<cr>

response:

OK

3.5.1.2 Check SMS Service Centre number

The SMS are sent by the TRIZIUM to a service centre (SMSC) where the message is dispatched towards its final destination or is kept until the delivery is possible. To ensure a correct behavior of this service the number of the service centre must be the one your network operator supports.

To check which number is stored as the SMSC:

- send command **AT+CSCA?<cr>**
- wait for response in the format:
+CSCA: <number>,<type>

OK

where:

<number> is the SMSC number

<type> is the SMSC number type:

- 145 – international numbering scheme (number begins with "+")
- 129 – national numbering scheme



TIP: This settings remains stored in the SIM card until it is changed or deleted, so this operation may be done only once if the SIM Card is not changed. The setting is maintained even after power down.

For example:

1- Let's assume you want to check your SMSC number:

command:

AT+CSCA? <cr>

response:

+CSCA: +393359609600

OK

3.5.1.3 Add SMS Service Centre number (only if required)

If your previously check for SMSC returned an empty field:

+CSCA: ,129

or if the SMSC number stored does not correspond to the desired one, then the new number has to be stored. In this way the previously stored number will be overwritten.

- send command **AT+CSCA=<number>,<type><cr>**

where:

<number> is the desired SMSC number

<type> is the SMSC number type:

- 145 – international numbering scheme (number begins with "+")
- 129 – national numbering scheme

- wait for **OK**

For example:

1- Let's assume your desired SMSC number is +39335123456 (stored in international format):

command:

AT+CSCA=+39335123456,145<cr>

response:

OK

3.5.1.4 Select New Messages indication behavior

When the device receives a new message a unsolicited indication is generated, this indication may be sent to the DTE, buffered if the DTE is busy (for example during a data call) or discarded.

To set the desired behavior:

- send command **AT+CNMI=<mode>,<mt>,<bm>,<ds>,0<cr>**

where:

<mode> unsolicited result code buffering option

- 0 – buffer unsolicited result codes in the TA in case the DTE is busy, e.g. a data call is active meanwhile.
- 1 – Discard indication and reject new received message unsolicited result codes when TA-TE link is reserved, otherwise forward them to the TE.
- 2 – buffer unsolicited result codes in the TA in case the DTE is busy and flush them to the TE after reservation. Otherwise forward them directly to the TE.

<mt> is the desired behavior for SMS delivery:

- 0 – When a new SMS is received, no indication is sent to the DTE.
- 1 – When a new SMS is received a unsolicited indication is sent to the DTE:

+CMTI: <memr>,<index>

where:

<memr> - memory storage where the new message is stored (usually "SM")
<index> - location index on the memory where the new SMS is stored

- 2 – When a new SMS is received a unsolicited indication is sent to the DTE (except class 2 messages and messages in the message waiting indication group):

+CMT: [<alpha>],<length><CR><LF><pdu>(PDU mode enabled)

where:

<alpha> - alphanumeric representation of originator/destination number corresponding to the entry found in MT phonebook.

<length> - PDU length

<pdu> - PDU message

or

+CMT: <oa>,[<alpha>],<sects>[,<tooa>,<fo>,<pid>,<dsc>,<sca>,<tosca>,<length>]<CR><LF><data> (text mode enabled; about parameters in italic, refer command +CSDH)

where:

<oa> - originator address number

<alpha> - alphanumeric representation of <oa> or <da>

<sects> - arrival time of the message to the SC

<tooa>,<tosca> - type of number <oa> or <sca>

145 - number in international format (contains the "+")

129 - number in national format

<fo> - first octet of GSM 03.40

<pid> - Protocol Identifier

<dsc> - Data Coding Scheme

<sca> - Service Centre number

<length> - text length

<data>- text mode

Class 2 messages and messages in the message waiting indication group (stored message) result in indication as defined in <mt> = 1.

- 3 – When a new SMS , Class 3 is received an unsolicited indication ,defined in <mt> = 2 is sent to the DTE. Messages of other data coding schemes result in indication as defined in <mt> = 1.

<bm> - broadcast reporting option

- 0 – Cell Broadcast Messages are not sent to the DTE

- 1 – NOT SUPPORTED

- 2 – New Cell Broadcast Messages are sent to the DTE with the unsolicited result code:

+CBM: <length><CR><LF><PDU> (in PDU mode)

or

+CBM:<sn>,<mid>,<dcs>,<pag>,<pags><CR><LF><text> (in text mode)

where:

<length> - PDU length
<PDU> - message PDU
<sn> - message serial number
<mid> - message ID
<dcs> - Data Coding Scheme
<pag> - page number
<pages> - total number of pages of the message
<text> - message text

<ds> is the desired behavior for SMS Status Report delivery:

- 0 – When a new SMS Status Report is received, no indication is sent to the DTE.
- 1 – When a new SMS Status Report is received an unsolicited indication is sent to the DTE reporting the whole message text/PDU depending on the mode selected:

+CDS: <length><CR><LF><pdu> (PDU mode selected)

or

+CDS: <fo>,<mr>,,,<scts>,<dt>,<st> (text mode selected)

where:

<length> - PDU length
<pdu> - message PDU
<fo> - first byte (octet) of message PDU
<mr> - message reference
<scts> - day & time of message arrival to the Service Centre
<dt> - day & time of message delivery
<st> - message status as coded in the PDU

- 2 – When a new SMS Status Report is received it is stored and then an unsolicited indication is sent to the DTE reporting the message position:

+CDSI: <memr>,<index>

where:

<memr> - message storage where the Status Report has been stored
<index> - message index position on the storage.

<bfr> - is the handling method for buffered result codes when <mode> 1 or 2 is enabled:

- 0 – TA buffer of unsolicited result codes defined within this command is flushed to the TE when <mode> 1 or 2 is entered (OK response shall be given before flushing the codes)
- 1 – TA buffer of unsolicited result codes defined within this command is cleared when <mode> 1 or 2 is entered.

- wait for **OK**



TIP: In this command description the values that are always 0 are parameter reserved for future use, in the current software revision the only value supported is 0.

For example:

1- Let's assume you want to eliminate all the unsolicited codes that may be sent when receiving SMS & Status Report:

command:

```
AT+CNMI= 0,0,0,0,0<cr>
```

response:

OK

For example about a new message indication:

1- Let's assume you receive a new SMS delivery (AT+CNMI=1,1,0,0,0) and this new message is stored on the SIM "SM" storage at the location number 7; the unsolicited code you will receive (if code is enabled) is:

unsolicited code:

```
+CMTI: "SM",7
```

2- Let's assume you receive a new SMS Status Report delivery (AT+CNMI=1,0,0,2,0) and this new message is stored on the SIM "SM" storage at the location number 8; the unsolicited code you will receive is:

unsolicited code:

```
+CDSI: "SM",8
```

3.5.1.5 Set Text Mode Parameters (only in TEXT mode)

When the device is set to operate with Text SMS not with PDU, the SMS parameters that usually reside on the header of the PDU must be set apart with the command +CSMP.

The parameters to be set are:

- Message Format
- Validity Period
- Protocol Identifier
- Data Coding Scheme

The meaning and format of the parameters is:

- **Message format**, like defined for the first octet of message according to GSM 3.40:

The format is an 8-bit parameter divided into 6 fields and then reported as an integer:

b7	b6	b5	b4	b3	b2	b1	b0
RP	UDHI	SRR	VPF		RD	MTI	

where

MTI message type parameter:

0 1 - SMS Submit (only value supported)

RD reject duplicates parameter

0 - don't reject duplicates SMS in SC

1 - reject duplicates on SC

VPF validity period format

0 0 - Validity period NOT present

1 0 - VP integer represented (relative)

1 1 - VP semi octet represented (absolute)

0 1 - reserved

SRR status report request

0 - status report not requested

1 - status report requested

UDHI user data Header Information

0 - No Header on PDU

1 - Header present on PDU

RP reply path

0 - RP not set

1 - RP set

- **Validity Period** numerical if in relative format or string if in absolute format

This parameter represents the validity period for the SMS after which the message should be disregarded instead of being delivered.

If in relative format (see VPF parameter) it is an integer:

- 0 to 143 – corresponding to (VP + 1) x 5 minutes
- 144 to 167 – corresponding to 12 hours + ((VP -143) x 30 minutes)
- 168 to 196 – corresponding to (VP - 166) x 1 day
- 197 to 255 – corresponding to (VP - 192) x 1 week

If in absolute format it is a string in the format:

"gg/MM/YY,hh:mm:ss±tz"

where

- gg day of expiration (2 characters)
- MM month of expiration (2 characters)
- YY year of expiration (2 characters)
- hh hour of expiration (2 characters)
- mm minute of expiration (2 characters)
- ss second of expiration (2 characters)
- ± sign of the time zone (+ or -)
- tz time zone (2 characters)

- Protocol Identifier in numerical format:

This parameter identifies the protocol used by the receiver entity and informs the SC that the conversion from SMS to that protocol should be done while delivering the message.

Protocol ID	Conversion towards..
0	Implicit (default)
33	telex (or teletex reduced to telex format)
34	group 3 telefax
35	group 4 telefax
36	voice telephone (i.e. conversion to speech)
37	ERMES (European Radio Messaging System)
38	National Paging system (known to the SC)
39	Videotex (T.100/T.101)
40	teletex, carrier unspecified
41	teletex, in PSPDN
42	teletex, in CSPDN
43	teletex, in analog PSTN

44	teletex, in digital ISDN
45	UCI (Universal Computer Interface, ETSI DE/PS 3 01-3)
46-47	(reserved, 2 combinations)
48	a message handling facility (known to the SC)
49	any public X.400-based message handling system
50	Internet Electronic Mail
51-55	(reserved, 5 combinations)
56-62	values specific to each SC, usage based on mutual agreement between the SME and the SC (7 combinations available for each SC)
63	A GSM mobile station. The SC converts the SM from the received TP-Data-Coding-Scheme to any data coding scheme supported by that MS (e.g. the default).
64	Short Message Type 0
65	Replace Short Message Type 1
66	Replace Short Message Type 2
67	Replace Short Message Type 3
68	Replace Short Message Type 4
69	Replace Short Message Type 5
70	Replace Short Message Type 6
71	Replace Short Message Type 7
72..94	Reserved
95	Return Call Message
96..126	Reserved
127	SIM Data download

- Data coding Scheme as defined by GSM 3.38 – in numerical format

The DCS is an 8-bit parameter reported as an integer, the default value is 0, otherwise for simplicity, we report only the most useful DCS, for further Schemes refer to GSM 3.38

b7	b6	b5	b4	b3	b2	b1	b0
-----------	-----------	-----------	-----------	-----------	-----------	-----------	-----------

1	1	1	1	0	Alphabet	Class
----------	----------	----------	----------	----------	-----------------	--------------

where

Alphabet

0 - default Alphabet

1 - 8 bit

Class

0 0 - Class 0

0 1 - Class 1

1 0 - Class 2

1 1 - Class 3



TIP: The default value for DCS = 0 represents the default SMS sent by a mobile. If you don't need any particular data coding scheme use DCS=0.



NOTE: Not all the DCS combinations described in the GSM 3.38 are supported, both by the network and by the Telit TRIZIUM. Some features may be not implemented at network level or at device level, resulting in a +CMS ERROR: 303 (operation not supported) result code. If this happens then use a different DCS.

- send command **AT+CSMP=<fo> , <vp> , <pid> , <dc><cr>**

where:

<fo>: Message format

<vp>: Validity Period

<pid>: Protocol Identifier

<dc>: Data coding Scheme

- wait for **OK**

For example:

1- Let's assume you want to set the SMS parameters to the values:

- Message Format:

- SMS submit
- don't reject duplicates
- VP Format integer (relative)

- status report not requested
- No Header on PDU
- Reply path not set

Hence, the message format is the binary number 00010001 corresponding to the integer 17.

- Validity period 24 hours corresponding to an integer value 167.
 $12 \text{ hours} + ((167 - 143) \times 30 \text{ min}) = 24 \text{ hours}$
- Protocol ID implicit (SMS sent to a mobile terminal) corresponding to a value 0.
- DCS default value 0.

command:

```
AT+CSMP= 17,167,0,0
```

response:

OK

2- Let's assume you want to set the SMS parameters to the values:

- Message Format:
 - SMS submit
 - don't reject duplicates
 - VP Format semi octet (absolute)
 - status report requested
 - No Header on PDU
 - Reply path not set

Hence, the message format is the binary number 00111001 corresponding to the integer 57.

- Validity period format is absolute, hence it represents the expiration date of the message and the desired expiration date is for example 29/06/02 at 02:20 in the time zone of Italy (+1).

"29/06/02,02:20:00+1"

- Protocol ID implicit (SMS sent to a mobile terminal) corresponding to a value 0.
- Data Coding Scheme:
 - Default Alphabet
 - Class 0 (e.g. immediate display SMS)

Corresponding to the binary number 11110000 corresponding to the integer 240.

command:

```
AT+CSMP= 57,29/06/02,02:20:00+1,0,240
```

response:

OK

3.5.1.6 Select SMS Memory and check for memory space

There are various types of storage where the SMS can be stored, the Telit TRIZIUM provides two different storage:

"ME" - mobile equipment memory

"SM" - SIM Card memory

The SMS are usually stored (this is true for both the originated and the received SMS) in the SM storage, the "ME" storage is a read only one where the Class 0 messages received are stored (regardless of the selected active storage which may be "SM").

For this reason the "ME" storage can be selected to read the Class 0 messages.

The TRIZIUM allows the user to select a different storage for the read-delete, write-send, and reception-saving SMS operations.

- send command **AT+CPMS=<memr> , <memw> , <mems><cr>**

where:

<memr>: memory storage for Read and Delete commands

- "SM"

- "ME" (No Delete operations allowed)

<memw>: memory storage for Write and Send commands

<mems>: memory storage for new incoming message saving

- "SM" only

- wait for response in the format:

+CPMS:<usedr>,<totalr>,<usedw>,<totalw>,<useds>,<totals>

OK

where

<usedr> - number of SMS stored into <memr>

<totalr> - max number of SMS that <memr> can contain

<usedw> - number of SMS stored into <memw>

<totalw> max number of SMS that <memw> can contain

<useds> - number of SMS stored into <mems>

<totals> max number of SMS that <mems> can contain

From this response you can check if the selected storage has room for new SMSs, the free positions in the storage X (where X can be r,w,s) are <totalX> -<usedX>.

3.5.2 IRA character set

The character set used in SMS text mode is the IRA.

This set defines each char as a 7-bit value, hence from 0x00 to 0x7F. The table below reports all the chars supported and their hexadecimal code. To obtain the code for a char in the table remember that in the row it is reported the least significant nibble (4 bits) and in the column the most significant nibble. The empty cells correspond to reserved combinations.

		Most Significant Nibble							
		0x	1x	2x	3x	4x	5x	6x	7x
Least Significant Nibble	x0			SP ¹	0	@	P		p
	x1			!	1	A	Q	a	q
	x2			"	2	B	R	b	r
	x3			#	3	C	S	c	s
	x4			\$	4	D	T	d	t
	x5			%	5	E	U	e	u
	x6			&	6	F	V	f	v
	x7			'	7	G	W	g	w
	x8			(8	H	X	h	x
	x9)	9	I	Y	i	y
	xA	LF ²		*	:	J	Z	j	z
	xB			+	;	K		k	
	xC			,	<	L		l	
	xD	CR ³		-	=	M		m	
	xE			.	>	N		n	
	xF			/	?	O	£	o	

¹ - SP stands for space character

² - LF stands for Line Feed character

³ - CR stands for Carriage Return character

For example:

1- Let's assume you want to find the IRA code for the character '&':

From the table you find:

- most significant Nibble: 2
- least significant Nibble: 6

Hence the IRA code for the '&' character is the hexadecimal 0x26.

2- Let's assume you have the IRA code 0x6B and you want to find the corresponding character:

From the table you find at the position

- most significant Nibble: 6
- least significant Nibble: B

Hence, the character corresponding to the 0x6B IRA code is 'k'.

3.5.3 Writing a New SMS to storage

A new SMS can be written in the selected storage <memw> (in the current SW version only "SM" is supported) and then can be sent to the desired destination.

To write the new SMS:

- send command **AT+CMGW=" <da> "<cr>**

where:

<da>: destination address

- wait for prompt ">"
- send SMS text (MAX 160 characters)
- end command with CTRL-Z character (0x1A hexadecimal) or abort command with ESC character (0x1B hexadecimal)
- wait for response:

Response	Reason	Action
+CMGW: <index> OK	Message has been successfully written in position number <index>	proceed ahead
ERROR	some error occurred	Enable the extended error codes report (see par.2.6.2.1) and retry.
+CMS ERROR: 330	SMSC address unknown	Insert SMSC address (see par. 3.5.1.3)
+CMS ERROR: 322	Memory Full	memory is full, hence delete some records and retry.

NOTE: if command is aborted with ESC character, then only the OK result code is returned.

For example:

1- Let's assume you want to write a new SMS to the storage and the destination address is the number +39338123456789. We suppose you already have set up the device for text SMS mode as described on the previous paragraphs:

command:

`AT+CMGW="+39338123456789"`

response:

>

now you can insert the message text in IRA format (note that the IRA format and ASCII format coincide for the alphabet characters but not for the other).

.... here will be inserted the SMS message text....

conclude text with the character CTRL-Z

response:

`+CMGW: 3`

OK

In this case, the new SMS was successfully written to the location index 3 of the selected write memory (always "SM" SIM Card memory).

3.5.4 Sending an SMS previously stored

An already written SMS can be sent from the selected storage <memw> (in the current SW version only "SM" is supported).

To send the written SMS its location index is needed:

- send command **AT+CMSS=<index><cr>**

where:

<index>: SMS location index

- wait for response:

Response	Reason	Action
+CMSS: <mr> OK	Message has been successfully sent. <mr> represents the message reference number.	proceed ahead

ERROR	some error occurred	Enable the extended error codes report (see par.2.6.2.1) and retry.
+CMS ERROR: 330	SMSC address unknown	Insert SMSC address (see par. 3.5.1.3)
+CMS ERROR: 41	"Temporary Failure", may be that the device is not registered on any network	Check for signal strength and network registration (see par. 2.6.3)
+CMS ERROR: 331	No network service	Check for signal strength and network registration (see par. 2.6.3)
+CMS ERROR: 1	Unassigned number	The destination address number does not exist. Check it and repeat command.
+CMS ERROR: 42	network congestion	Retry later
+CMS ERROR: 96	Mandatory information missing	Check for destination address in the SMS, overwrite it and retry.

For example:

1- Let's assume you want to send a SMS that was written to the storage index position number 3. We suppose you already have set up the device for text SMS mode as described on the previous paragraphs:

command:

AT+CMSS=3

response:

+CMSS: 1

OK

In this case, the SMS was successfully sent to the destination and its network message reference number is 1.

3.5.5 Sending a new SMS without storing it

A new SMS can be sent directly to the network without storing it.

- send command **AT+CMGS="<da>"<cr>**

where:

<da>: destination address

- wait for prompt ">"
- send SMS text (MAX 160 characters)
- end command with CTRL-Z character (0x1A hexadecimal) or abort command with ESC character (0x1B hexadecimal)
- wait for response:

Response	Reason	Action
+CMGS: <mr> OK	Message has been successfully sent. <mr> represents the message reference number.	proceed ahead
ERROR	some error occurred	Enable the extended error codes report (see par.2.6.2.1) and retry.
+CMS ERROR: 330	SMSC address unknown	Insert SMSC address (see par. 3.5.1.3)
+CMS ERROR: 41	"Temporary Failure", may be that the device is not registered on any network	Check for signal strength and network registration (see par. 2.6.3)
+CMS ERROR: 331	No network service	Check for signal strength and network registration (see par. 2.6.3)
+CMS ERROR: 1	Unassigned number	The destination address number does not exist. Check it and repeat command.
+CMS ERROR: 42	network congestion	Retry later
+CMS ERROR: 96	Mandatory information missing	Check for destination address in the SMS, overwrite it and retry.
OK	command aborted by user	you issued a ESC char

For example:

1- Let's assume you want to directly send a new SMS to the destination address number +39338123456789. We suppose you already have set up the device for text SMS mode as described on the previous paragraphs:

command:

```
AT+CMGS="+39338123456789"
```

response:

```
>
```

now you can insert the message text in IRA format (note that the IRA format and ASCII format coincide for the alphabet characters but not for the other).

.... here will be inserted the SMS message text to be sent....

conclude text with the character CTRL-Z

response:

```
+CMGW: 4
```

OK

In this case, the new SMS was successfully sent to the SC and its network reference number is 4.

Do not confuse message reference with message index position, the first indicates the network reference for identifying the sent message (the eventually requested status report will have the same reference) while the second indicates the position where the message has eventually been stored in memory.

3.5.6 Deleting an SMS

An already written/received SMS can be deleted from the selected storage (in the current SW version only "SM" is supported).

To delete the SMS its location index is needed:

- send command **AT+CMGD=<index><cr>**

where:

<index>: SMS location index

- wait for response:

Response	Reason	Action
OK	Message has been successfully deleted.	proceed ahead
ERROR	some error occurred	Enable the extended error codes report (see par.2.6.2.1) and retry.
+CMS ERROR: 321	Invalid memory index e.g. the given record was already empty	Check the <index> number and retry.

For example:

1- Let's assume you want to delete a previously written SMS that was written to the storage index position number 3. We suppose you already have set up the device for text SMS mode as described on the previous paragraphs:

command:

AT+CMGD=3

response:

OK

In this case, the SMS was successfully deleted.

2- Let's assume you want to delete a received SMS that was stored to the index position number 7:

command:

AT+CMGD=7

response:

OK

3.5.7 Reading an SMS

A new SMS can be read with the command:

- send command **AT+CMGR=<index><cr>**

where:

<index>: SMS location index

- wait for response in the format:

For a received message:

+CMGR: <stat>,<oa>,,<scts> [,<tooa>,<fo>,<pid>,<dcs>,<sca>,<tosca>,<length>]
<CR><LF><text>

For a sent message:

+CMGR: <stat>,<da>[,<toda>,<fo>,<pid>,<dcs>,,<sca>,<tosca>,<length>]
<CR><LF><text>

For a status report message:

+CMGR: <stat>,<fo>,<mr>,,<scts>,<dt>,<st>

where:

- <stat> - status of the message
 - "REC UNREAD" - new message
 - "REC READ" - read message
 - "STO UNSENT" - stored message not yet sent
 - "STO SENT" - stored message already sent
- <fo> - first octet of message PDU
- <mr> - message reference
- <scts> - day and time of message arrival at Service Center
- <dt> - day and time of message delivery
- <st> - message status as coded in the message PDU
- <pid> - Protocol Identifier
- <dcs> - Data Coding Scheme
- <oa> - sender number
- <da> - destination number
- <sca> - Service Center number
- < tooa>, <toda >, <tosca> - type of number <oa>, <da>, <sca>
 - 145 - international number (contains "+" character)
 - 129 - national number
- <length> - length of the message text in characters
- <text> - message text

NOTE: If status of the message is 'received unread', status in the storage changes to 'received read'.

NOTE: If the requested record is empty or is not existing then a +CMS ERROR: 321 error code is reported.

For example:

1- Let's assume you want to read the SMS that is stored at the position index 4. We suppose you already have set up the device for text SMS mode as described on the previous paragraphs:

command:

AT+CMGR=4

response:

+CMGR: "STO UNSENT", "+393351234565"

Telit Test Message for Text Mode SMS.

OK

In this case the SMS was successfully read, the text contained was:

" Telit Test Message for Text Mode SMS."

The message was written to the storage by user (STO) but still not sent (UNSENT) to the destination address that's the number +393351234565

2- Let's assume you want now to read the SMS that is stored at the position index 5:

command:

AT+CMGR=5

response:

+CMGR: "REC UNREAD", "+393381234567890", "29/06/01,12:30:04+01"

Telit Test Message for Text Mode SMS RECEIVING.

OK

In this case the SMS was successfully read, the text contained was:

" Telit Test Message for Text Mode SMS RECEIVING."

The message was received (REC) from the number +393381234567890 at 12:30:04 the day 29/06/01 in the European time zone +1.

After this read command the message at index 5 becomes REC READ.

3.5.8 Listing a group of SMSs

The SMS can be grouped into 5 different groups depending on their status:

- REC UNREAD - received messages still not read
- REC READ - received messages already read
- STO UNSENT - written messages not yet sent
- STO SENT - written messages already sent
- ALL - all types of messages

It is possible to have the list of all the messages in one group:

- send command **AT+CMGL=<stat><cr>**

where:

<stat> - status group of the message

- "REC UNREAD"** - new message
- "REC READ"** - read message
- "STO UNSENT"** - stored message not yet sent
- "STO SENT"** - stored message already sent
- "ALL"** - all messages

- wait for response in the format:

For every message in the group:

**+CMGL: <index>,<stat>,<oa/da> [,,<tooa/toda>,<length>]
<CR><LF><text>**

where:

<index> - message index position on the storage

<stat> - status of the message

- "REC UNREAD"** - new message
- "REC READ"** - read message
- "STO UNSENT"** - stored message not yet sent
- "STO SENT"** - stored message already sent

<oa/da> - sender number/destination number

< tooa/toda > - type of number <oa/da>

145 - international number (contains "+" character)

129 - national number

<length> - length of the message text in characters

<text> - message text

NOTE: If status of the message is 'received unread', status in the storage changes to 'received read'.

For example:

1- Let's assume you want to list all the SMS received read that are stored. We suppose you already have set up the device for text SMS mode as described on the previous paragraphs:

command:

```
AT+CMGL="REC READ"
```

response:

```
+CMGL: 5, "REC READ", "+393381234567890"
```

```
Telit Test Message for Text Mode SMS RECEIVING.
```

```
+CMGL: 8, "REC READ", "+393381234567890"
```

```
Telit Second Test Message for Text Mode SMS RECEIVING.
```

```
OK
```

In this case the SMS group was successfully read, the messages Received UNREAD were two in the position indexes 5 & 8. The optional parameters <tooa/toda> and <length> were not shown.

3.6 Using General Purpose Input/Output pins

The **Telit TRIZIUM** provides 12 General Purpose Input/Output pins, these pins can be configured via AT commands as Inputs, Outputs and two of them as "alternate function".

The "alternate function" are supported by pins GPIO6, which can be configured to become an alarm output pin that reflects the alarm status, and GPIO7 which can be configured to become a buzzer output pin.

With these pins your application can control external hardware directly using the **Telit TRIZIUM** pins, with little or even no hardware added.

3.6.1 GPIO pin setup

Before using the GPIO pin, you must configure them to select their direction or alternate function

3.6.1.1 Setting GPIO pin as OUTPUT

When you set a GPIO as output, you must specify also the value that the pin output must take:

- Send command **AT#GPIO=<pin>,<value>,1<cr>**

where:

<pin> is the GPIO pin number at which the command applies:

1 – GPIO1	8 – GPIO8
2 – GPIO2	9 – GPIO9
3 – GPIO3	10 – GPIO10
4 – GPIO4	11 – GPIO11
5 – GPIO5	12 – GPIO12
6 – GPIO6	13 – GPIO13
7 – GPIO7	

<value> is the GPIO pin value that the pin will assume:

0 – LOW
1 – HIGH

- wait for response **OK**

 **NOTE:** The #GPIO setting is not saved and will be lost on power off, so at start-up repeat pin initialization commands. At start-up the setting for GPIO6 and GPIO7 instead is maintained even after a shutdown to permit alarm & buzzer feature to work always.

For example:

1- Let's assume you want to set GPIO3 pin as Output and you want it to be in LOW status:

command:

```
AT#GPIO=3,0,1<cr>
```

response:

OK

In this case, the GPIO3 pin was successfully put in output direction and its status has been set to LOW.

3.6.1.2 Setting GPIO pin as INPUT

When you set a GPIO as input, you must specify also a dummy value for the pin state:

- Send command **AT#GPIO=<pin>,<dummy_value>,0<cr>**

where:

<pin> is the GPIO pin number at which the command applies:

1 – GPIO1	8 – GPIO8
2 – GPIO2	9 – GPIO9
3 – GPIO3	10 – GPIO10
4 – GPIO4	11 – GPIO11
5 – GPIO5	12 – GPIO12
6 – GPIO6	13 – GPIO13
7 – GPIO7	

<value> is a dummy value can be either:

- 0 – dummy value
- 1 – dummy value

- wait for response **OK**

 **NOTE:** The #GPIO setting for all GPIO except from GPIO6, GPIO7, is not saved and will be lost on power off, so at start-up repeat pin initialization commands.

At start-up all the GPIOs except from GPIO6 & GPIO7 are configured by default as INPUT, but the setting for GPIO6 and GPIO7 instead is maintained even after a shutdown to permit alarm & buzzer feature to work always.

For example:

1- Let's assume you want to set GPIO4 pin as Input:

command:

```
AT#GPIO=4,0,0<cr>
```

response:

OK

In this case, the GPIO4 pin was successfully put in input direction.

3.6.2 GPIO pin use

After having set-up the GPIO pin direction you can query the input status of an INPUT pin or set the output status of an OUTPUT pin.

3.6.2.1 Querying GPIO pin status

To query for the pin status:

- Send command **AT#GPIO=<pin>,2<cr>**

where:

<pin> is the GPIO pin number at which the command applies:

1 – GPIO1	8 – GPIO8
2 – GPIO2	9 – GPIO9
3 – GPIO3	10 – GPIO10
4 – GPIO4	11 – GPIO11
5 – GPIO5	12 – GPIO12
6 – GPIO6	13 – GPIO13
7 – GPIO7	

- wait for response in the format:

```
#GPIO: <dir>,<stat>
```

OK

where:

<dir> - GPIO<pin> direction setting

<stat> - status of the pin

0 - LOW

1 - HIGH

 **NOTE:** In case the GPIO pin direction is set to ALTERNATE FUNCTION (2), then the reported <stat> has no meaning and shall not be kept as valid, but shall be treated as a dummy value.

 **TIP:** The query reports depending on the pin direction:

- the read pin status in case the direction is input;
- the previously set pin status in case the direction is output.

In any case, you can know if the pin at the query moment is high or low and the pin direction.

For example:

1- Let's assume you want to query the GPIO3 pin for its status:

command:

```
AT#GPIO=3,2<cr>
```

response:

```
#GPIO: 0,1
```

OK

In this case, the GPIO3 pin was set in input direction and its status has been measured to be HIGH.

2- Let's assume you want to query the GPIO4 pin for its status:

command:

```
AT#GPIO=4,2<cr>
```

response:

```
#GPIO: 1,0
```

OK

In this case, the GPIO4 pin was set in output direction and its status is LOW.

3- Let's assume you want to query the GPIO6 pin for its status:

command:

```
AT#GPIO=6,2<cr>
```

response:

```
#GPIO: 2,0
```

OK

In this case, the GPIO6 pin was set in "alternate function" direction and therefore works as alarm output. The reported status = LOW has no meaning.

3.6.2.2 Setting GPIO pin output status

To set the pin status (when pin is set as OUTPUT):

- Send command **AT#GPIO=<pin>,<value>,1<cr>**

where:

<pin> is the GPIO pin number at which the command applies:

- 2 – GPIO2 (*only OUTPUT pin - OPEN COLLECTOR*)
- 3 – GPIO3
- 4 – GPIO4
- 5 – GPIO5
- 6 – GPIO6
- 7 – GPIO7

<value> is the pin value to be set and can be:

- 0 – LOW
- 1 – HIGH

- wait for response **OK**

For example:

1- Let's assume you want to set the GPIO3 pin HIGH:

command:

```
AT#GPIO=3,1,1<cr>
```

response:

```
OK
```

In this case, the GPIO3 pin was set in output direction and its status has been set to HIGH.

3.6.2.3 Using GPIO6 pin as ALARM OUTPUT (alternate function)

When you set the GPIO6 pin as alarm output function, the pin reports the alarm state following the +CALA settings. To set the pin in alternate function you must specify also a dummy value for the pin state:

- Send command **AT#GPIO=6,<dummy_value>,2<cr>**

where:

<value> is a dummy value can be either:

- 0 – dummy value

1 – dummy value

- wait for response **OK**



TIP: Remember that the alternate function places the GPIO6 pin always in OUTPUT direction and since the GPIO6 pin value is controlled by the internal software, the corresponding function (+CALA) must be setup properly.



NOTE: The #GPIO6 direction setting is saved and will be kept after a power off.

For example:

1- Let's assume you want to set GPIO6 pin as ALARM OUTPUT:

command:

```
AT#GPIO=6,0,2<cr>
```

response:

OK

In this case, the GPIO6 pin was successfully put in alarm output direction.

3.6.2.4 Using GPIO7 pin as BUZZER OUTPUT (alternate function)

When you set the GPIO7 pin as buzzer output function, the pin will output a waveform suitable to drive a Buzzer, provided a simple external mosfet driver is developed and that the #SRP settings are adequate. To set the pin in alternate function you must specify also a dummy value for the pin state:

- Send command **AT#GPIO=7 , <dummy_value> , 2<cr>**

where:

<value> is a dummy value can be either:

0 – dummy value

1 – dummy value

- wait for response **OK**



TIP: Remember that the alternate function places the GPIO7 pin always in OUTPUT direction and since the GPIO7 pin value is controlled by the internal software, the corresponding function (#SRP) must be setup properly.



NOTE: The #GPIO7 direction setting is saved and will be kept after a power off.

For example:

1- Let's assume you want to set GPIO7 pin as BUZZER OUTPUT:

command:

```
AT#GPIO=7,0,2<cr>
```

response:

OK

In this case, the GPIO7 pin was successfully put in buzzer output direction.

3.7 Clock/Alarm function

The **Telit TRIZIUM** provides a Real Time Clock and Alarm embedded in the product; it is therefore possible to set-up the proper time, check the actual time, set-up an alarm time at which the alarm will be triggered with various behavior depending on the +CALA setting.

The only requirement is that the power input to the **Telit TRIZIUM** has to be guaranteed without interruptions, the **Telit TRIZIUM** has no backup battery; therefore it will lose the time setting if its power supply is interrupted.

On Alarm trigger the **Telit TRIZIUM** can:

- automatically Wake-up fully operative from shutdown as if the ON/OFF
- automatically Wake-up from shutdown in a special status namely "alarm status" where it will not look for or try to register into any network, as if it would be off, except from the fact that it proceeds with the alarm action and it can receive commands to return completely operative or shutdown immediately.
- If already ON at alarm trigger time, simply proceed with the Alarm action

Once Woken-up the **Telit TRIZIUM** proceeds with the chosen action that can be

- issue an unsolicited code "+ALARM: <user_text>" on the serial port until a 90s timeout expires or a special Wake-up command is received
- play an Alarm tone until a 90s timeout expires or a special Wake-up command is received
- rise the pin GPIO6 until a 90s timeout expires or a special Wake-up command is received
- any combination of these actions

With these features, the **Telit TRIZIUM** for example can:

- Wake-up itself and its controlling hardware by using the GPIO6 pin at the desired time, so timely surveys can be programmed without the need to keep the any hardware on and therefore reducing power consumption to a minimum.
- Activate some special hardware on time trigger event with the GPIO6 pin.
- Alert the controlling application that the alarm time has come with the unsolicited code "+ALARM:<user_text>"
- Alert the user with the alarm tone played

3.7.1 Clock date/time

Before using the Alarm feature, you must regulate the internal clock.

3.7.1.1 Regulate the Clock

- Send command **AT+CCLK="<time>"<cr>**

where:

<time> is the time string in the format:

yy/MM/dd, hh:mm:ss±zz

where:

yy : two digits year (00-99)

MM : two digits month (01-12)

dd : two digits day (01-31)

hh : two digits hour (00-24)

mm : two digits minute (00-60)

ss : two digits seconds (00-60)

±zz: signed two digits timezone (-11 - +11)

- wait for response **OK**



TIP: Remember that the string time has to be encapsulated in double brackets.



NOTE: The time will start immediately after the time setting command.

For example:

1- Let's assume you want to regulate your clock to 7 November 2002 at 12h 24m 30s for the time zone +01h central Europe:

command:

AT+CCLK="02/11/07,12:24:30+01"<cr>

response:

OK

In this case, the time was successfully set.

3.7.1.2 Read the current date/time

- Send command **AT+CCLK?<cr>**
- wait for response in the format:

+CCLK: <time>

OK

where:

<time> is the time string in the same format as before.

For example:

1- Let's assume you want now to read the current time:

command:

AT+CCLK?<cr>

response:

+CCLK="02/11/07,12:26:47+01"<cr>

OK

In this case the current date/time is: 7 November 2002 12h 26m 47s (time zone +1h - Central Europe).

3.7.2 Alarm function

Once the current time has been set, the alarm function can be setup.

3.7.2.1 Regulate the Alarm time & behavior

- Send command **AT+CALA="<time>",<type>,"<text>"<cr>**

where:

<time> is the Alarm time string in the same format of the clock setting command:

yy/MM/dd,hh:mm:ss±zz

where:

yy : two digits year (00-99)

MM : two digits month (01-12)

dd : two digits day (01-31)

hh : two digits hour (00-24)

mm : two digits minute (00-60)

ss : two digits seconds (00-60)

±zz: signed two digits timezone (-11 - +11)

<type> is the Alarm behavior:

1 - the TRIZIUM simply wakes up fully operative as if the ON/OFF pin had been pressed. If the device is already ON at the alarm time, then it does nothing.

2 - the TRIZIUM wakes up in "alarm mode" if at the alarm time it was off, otherwise it remains fully operative. In both cases, the TRIZIUM issues an unsolicited code every 3s:
`+ALARM: <text>`

Where <text> is the other +CALA parameter previously set.

The device keeps on sending the unsolicited code every 3s until a #WAKE or #SHDN command is received or a 90s timeout occurs. If the device is in "alarm mode" and it does not receive the #WAKE command within 90s then it shuts down. (Default)

3 - the TRIZIUM wakes up in "alarm mode" if at the alarm time it was off, otherwise it remains fully operative. In both cases the TRIZIUM starts playing the alarm tone on the selected path for the ringer (see command #SRP)

The device keeps on playing the alarm tone until a #WAKE or #SHDN command is received or a 90s timeout occurs. If the device is in "alarm mode" and it does not receive the #WAKE command within 90s then it shuts down.

4 - the TRIZIUM wakes up in "alarm mode" if at the alarm time it was off, otherwise it remains fully operative. In both cases the TRIZIUM brings the pin GPIO6 high, provided its <dir> has been set to alarm output, and keeps it in this state until a #WAKE or #SHDN command is received or a 90s timeout occurs. If the device is in "alarm mode" and it does not receive the #WAKE command within 90s then it shuts down

5 - the TRIZIUM will make both the actions as for type=2 and type=3.

6 - the TRIZIUM will make both the actions as for type=2 and type=4.

7 - the TRIZIUM will make both the actions as for type=3 and type=4.

<text> is the Alarm unsolicited text string in the +ALARM: <text> code

- wait for response **OK**



***TIP:** Remember that the string time has to be encapsulated in double brackets, furthermore the Alarm time will not be computed for different timezone, therefore the alarm time will always refer to the same timezone as the clock setting regardless the timezone set in the +CALA command.*



***NOTE:** if you use the GPIO6 pin as ALARM OUTPUT, then you MUST set its direction to "alternate function" (see par. 3.6.2.3) otherwise the pin will not respond to the alarm settings.*

In case the alarm mode is equal to 1,3,7 then a dummy empty text shall be inserted "".

 **NOTE:** *if you use the unsolicited codes +ALARM: <text>, then you must fix the port speed rate (see par. 2.6.1) and store it in the active profile (see command &W), in order to make the Telit TRIZIUM boot with the desired port speed, otherwise at the alarm wakeup, the module will start with the default port speed that may differ from yours.*

3.7.2.2 Stop the Alarm activity

When the alarm time expires, the module starts the alarm activity according to the alarm behavior parameter <type> selected.

To stop the Alarm activity there are three ways, you can either decide to exit from alarm and shutdown the device or exit from alarm and entering the normal operational status; otherwise you can leave the alarm go on until the 90s timeout is reached.

3.7.2.2.1 Exit from the alarm status and shutdown

- Send command **AT#SHDN<cr>**
- wait for response **OK**

At the OK result code, the device will end alarm activity and shutdown.

3.7.2.2.2 Exit from the alarm status and enter the normal operating mode

- Send command **AT#WAKE=0<cr>**
- wait for response **OK**

At the OK result code, the device will end alarm activity and enter normal operating mode. If the device was already in normal operating mode (alarm has started when the module was already ON), then with the command only the alarm activity is terminated.

3.7.2.3 Querying the Alarm status

When the device awakes by means of an alarm time expire, the module starts the alarm activity but not the network activity, permitting some operations to be done by the controlling application without registering the mobile in the network.

To check if the mobile is in the "alarm status" and therefore no network activity is done or if the device is in the normal operating status:

- Send command **AT#WAKE?<cr>**
- wait for response in the format:
+WAKE: <status>
OK

where:

<status> is the operating mode:

- 0 - normal operating mode
- 1 - alarm mode

 **NOTE:** *if the device is in the alarm mode no network activity is done, therefore the only commands that are accepted are the #WAKE and #SHDN ones.*

When in the alarm mode, no operation is allowed towards the network, therefore it is not possible to receive or send calls, SMS and whatever GSM/GPRS services.

3.7.2.3.1 Alarm operation example

For example:

1- Let's assume you have a battery powered device, a meteorological unit that measures every hour the conditions and therefore needs to send a new SMS every hour to the central server, for example indicating the whether status just measured. Let say your application shall consume the absolute minimum power to achieve the job, since it will be placed in a remote position where its battery shall last as long as possible and therefore it should shutdown completely and wake up every hour for just the time needed to measure & send the whether, successively shutdown.

- set up the time in the internal clock (only the first time..)

command:

AT+CCLK="02/11/07,12:24:30+01"<cr>

response:

OK

- set up the next alarm in order to raise the GPIO6 pin to power up the controlling application too.

command:

AT+CALA="02/11/07,13:24:30+01",0,6,"TIME TO MEASURE & SMS...!"<cr>

response:

OK

- shutdown the TRIZIUM and successively the controlling application.

command:

AT#SHDN<cr>

response:

OK

... after an hour..

The TRIZIUM will turn itself ON in "Alarm Mode" and contemporarily both rise the GPIO6 pin which turns on the power to the controlling application and issue every 3s an unsolicited code +ALARM: TIME TO MEASURE & SMS...!

- turn on the keep alive line in the controlling application that keeps itself ON.

- stop the alarm activity in the TRIZIUM (recognized by the +ALARM unsolicited code) and bring the TRIZIUM in operating mode

command:

AT#WAKE=0<cr>

response:

OK

- take the whether measure

- send the SMS with the whether data (see Sending a new SMS without storing it par. 3.5.5).

- read the current time.

command:

AT+CCLK?<cr>

response:

+CCLK="02/11/07,13:24:47+01"<cr>

OK

- calculate & set up the next alarm in order to raise the GPIO6 pin to power up the controlling application too.

command:

AT+CALA="02/11/07,14:24:47+01",0,6,"TIME TO MEASURE & SMS...!"<cr>

response:

OK

- shutdown the TRIZIUM and successively the controlling application.

command:

AT#SHDN<cr>

response:

OK

4 GPRS operations

4.1 Introduction

The General Packet Radio Services (GPRS) standard permits DATA transfers in a completely different way with respect to previous point to point communications made with Circuit Switch Data (CSD) GSM modems.

In CSD operations the modem establishes a connection with the other party (another modem) in such a way that all the Network devices in between are transparent to the data exchanged, simulating a real point to point connection, just as if the other party is directly connected with the controlling application of the modem. The other party can be either an Internet Service Provider (ISP) or a private server, but in any case, the arrival point must have a modem to connect to (Landline, ISDN or GSM CSD). The connection establishment procedure defines a particular path where all the information exchanged between the two peers flows and this path is reserved for exclusive use of these 2 peers for all the time the connection is active.

This approach has the drawbacks of a long time to set-up the link between the two peers (up to a minute) and a time counting bill which proceeds even if no data is exchanged because the path resources are reserved anyway; furthermore the speed of the data transfer is limited to 14400 bps.

An example of this kind of operation is shown in the following picture, where the point to point connection is between the two peers as if all the devices inside the dashed line are not present:

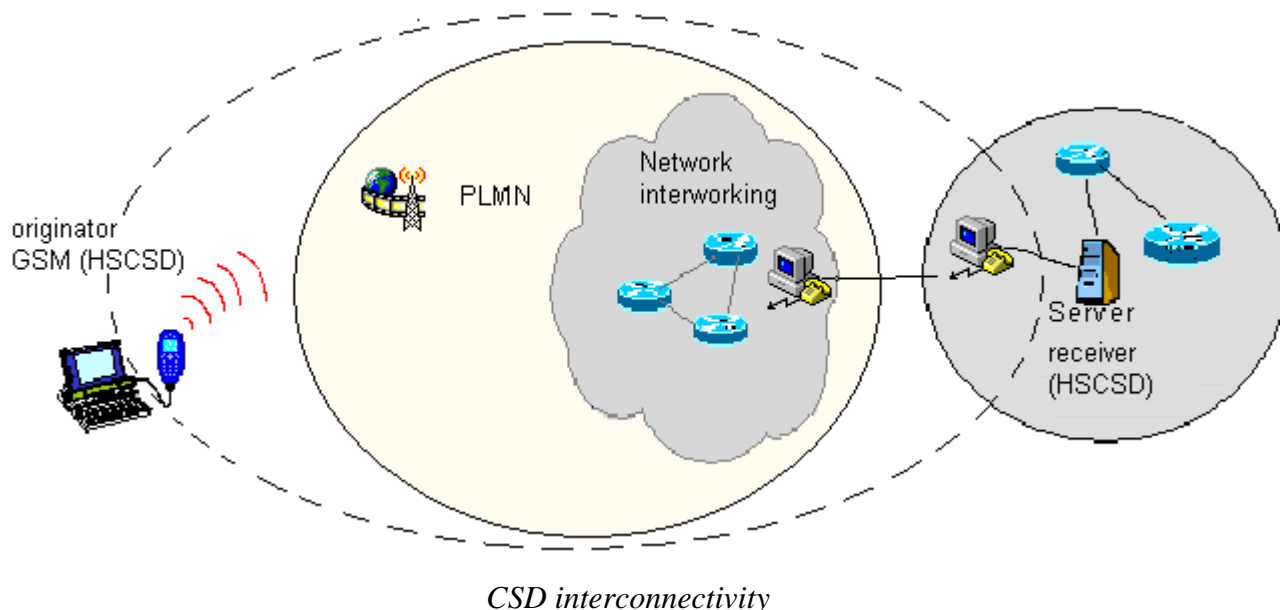

In GPRS operations instead, the connection is made directly towards internet as if the GPRS modem was a network IP socket interface. There's no data path reserved for the data exchange between the two peers, instead the resources are allocated dynamically on demand and the data exchanged is organized into packets typically TCP/IP, furthermore the maximum transfer speed can be much faster than GSM CSD.

An example of GPRS connection is shown in the following picture, where the GPRS connection is between the GPRS modem and the internet as if all the devices inside the dashed line are not present:

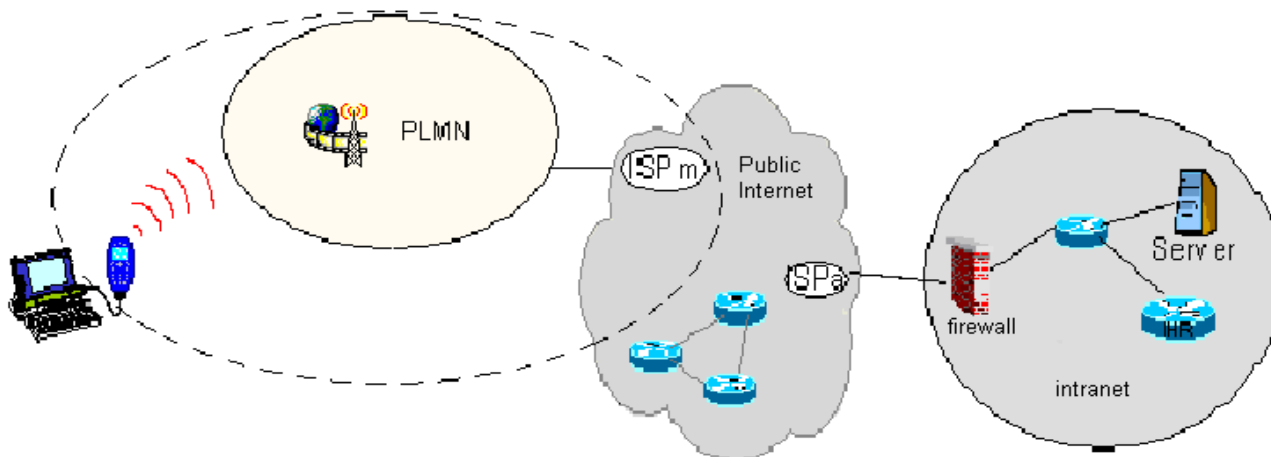

GPRS interconnectivity

Due to this kind of connection, when activating the GPRS connection you must provide the network parameters to enter through the internet point of the GPRS network ISP (Internet Service Provider) and not the phone number to be dialed; therefore it is not possible to establish a direct point to point GPRS connection between two modems as in CSD case, instead an internet tunneling must be done to achieve a point to point connection between two peers.

This approach as the immediate advantage of projecting the controlling application of the GPRS modem directly on the internet, ready to be accessed virtually from anywhere in the world at the same cost on the GPRS; actually the billing of the GPRS connection is based on the amount of data exchanged (number of packets transferred) independently from the time the connection is active or where these packet must be delivered. Therefore, it is possible to leave the controlling application always connected and ready to receive/send data on demand, while paying only for the data really exchanged.

The drawback of the GPRS connection is that the controlling application must have its own TCP/IP protocol stack embedded to decode the packets that arrive from GPRS and encode the ones to be sent through the internet.

There are few considerations than must be done on the GPRS connections:

- the GPRS connection speed with a GPRS class 8 multislot device is asymmetrical, 4 time slots in reception (57600 bps max) and 1 time slot in sending (14400 bps max).
- The controlling application of the module must have a TCP/IP - PPP software stack to interface with the GPRS modems.

- The controlling application must relay on some ISP that may be the Network Operator of the SIM to gain access to the internet through the GPRS connection.
- Because of the point before, the receiving application must have internet access either.
- Since the communication is based upon TCP/IP packets, then it is possible to talk contemporarily with more than one peer.
- When required, the data security in internet shall be guaranteed by security protocols over the TCP/IP that must be managed by the controlling application.

A GPRS modem can be in 3 different states:

- DETACHED, which corresponds to the "not reachable" condition of a GSM mobile;
- ATTACHED, which corresponds roughly to the "registered" condition of a GSM mobile;
- CONNECTED, which roughly corresponds to the connected status of a GSM mobile;

A thing that must be noted on the GPRS connect, is the fact that, if the mobile IP address (the internet address) is assigned by the ISP dynamically, then when the device is not connected it has no address and therefore it cannot be reached by internet requests. The same thing occurs in the case the GPRS device has a static IP address assigned to it by the ISP, but it is DETACHED or attached but it does not support network initiated context activation.

In these cases there's no possibility for the internet peer to "call" the GPRS device through internet, the only way to alert it is to call it in GSM mode (either a Data or a Voice call are suited) and the GPRS module application must recognize the caller, eventually abort the GSM call and connect to the internet in GPRS to receive the packets from the internet peer.

To explain further the differences between CSD and GPRS an example application made in both ways will be shown.

4.1.1 CSD application example

Let's suppose you have several remote meteorological measurement units spread around the territory, and you want to access them wirelessly through a GSM module in CSD operation.

For each remote unit, there's a modem to connect with the server application, with its own SIM card and unique phone number.

Now there are two possibilities:

- the server application calls on demand the remote units, provided it has stored their phone numbers in a private database.
- the remote units call the server application modem when needed and eventually retry in the case they found it busy; this time the phone number to be stored is only one, the server number which must be stored on the remote units.

In both cases, once connected, the remote unit sends the meteorological data to the server, which places it in a central database for further reading by anyone who accesses the meteorological internet site for example.

The drawback of this approach is that the CSD modem needs about 30s to establish the connection and, depending on the amount of data to be transferred (usually few hundreds bytes), some seconds to transfer them. So let say we pay a 40s call while we need only 10s to transfer data.

4.1.2GPRS application example

The same application can be made with the TRIZIUM using the GPRS feature.

The remote unit is always connected to the internet (at no charge) taking advance of the features of the GPRS system, when it needs to send data to the server application it simply fills the TCP/IP packets for the server with the meteorological data and gives them to the TRIZIUM to be delivered. The central server has a single modem to connect to the internet, receives the TCP/IP packets from all the remote units and places the contained data in the central database.

The advantage of using GPRS is that the remote unit is always connected and reachable and it pays only for the amount of data (small) transferred and not for the connection time as in CSD operations; in addition the call billing is equal for devices placed anywhere in the Network Operator State and the server can be anywhere in the World.

Furthermore, in the CSD operation the server shall have a set of modems and multiple phone lines to ensure that the calling units will not find it busy, while a single modem is enough for GPRS operation. The speed at which the packets can be transferred is up to 57600 bps (class 8 device), 4 times faster than CSD.

Now that's clear how GPRS works let see how to establish a connection:

4.2 Preliminary GPRS context parameters setting

4.2.1 Context parameter setting

The context parameters are all the set of information to identify the internet entry point interface provided by the ISP. With these parameter the GPRS network identifies the ISP to be used to gain access to the internet and defines the value of the IP address of the GPRS device once connected.

- send command

```
AT+CGDCONT=<cid>,"<type>","<APN>","<address>",<d_comp>,<h_comp>[,<pd1>,...,<pdn>]<cr>
```

where:

<cid> is the index number of the desired context to be written (up to 5 different context).

<type> is the Packet Data Protocol type

IP - Internet Protocol

PPP - Point to point protocol

<APN> is the Access Point Name, the logical name that selects the GGSN network connected

<Address> is the IP address associated with the terminal in the address space of the PDP.

"0.0.0.0" means dynamic.

<d_comp> is the data compression flag

0 - data compression OFF (default)

1 - data compression ON

<h_comp> is the header compression flag

0 - header compression OFF (default)

1 - header compression ON

<pd1>,...,<pdN> are the optional PDP parameter depending on the <type>

- wait for response:

Response	Reason	Action
OK	Context parameters have been successfully stored	proceed ahead
ERROR	some error occurred	Check parameters and retry.

For example:

1- Let's assume you want to set-up the GPRS context number 1(cid) with your GPRS connection parameters

apn: uni.tim.it

ip address: dynamically assigned by the ISP

Packet Data protocol: Internet Protocol (IP)

Data compression: OFF

Header compression: OFF

command:

```
AT+CGDCONT= 1,"IP","uni.tim.it","0.0.0.0",0,0 <cr>
```

response

OK

4.2.2 Minimum Quality of the Service Requested

The minimum quality of service requested parameters represent the boundary under which the connection quality is not anymore acceptable and will be terminated.

- send command

```
AT+CGQMIN=<cid> ,<precedence> ,<delay> ,<reliability> ,<peak>  
,<mean><cr>
```

where:

<cid> is the index number of the desired context to be written (up to 5 different context).

<precedence> is the precedence class

It applies when the network has a heavy duty and user precedence must be followed to ensure operations, the higher the priority the better the service.

0 - subscribed (default)

1 - High priority

2 - Normal priority

3 - Low priority

<delay> is the delay class

It represents the maximum allowable time delay class between the sending and the reception of a packet.

0 - subscribed (default)

- 1 - delay class 1
- 2 - delay class 2
- 3 - delay class 3
- 4 - delay class 4 (best effort)

<reliability> is the connection reliability class

It represents the connection reliability requested, the higher the number the less reliable the data exchanged.

- 0 - subscribed (default)
- 1 - reliability class 1 (acknowledged GTP,LLC and RLC; protected data)
- 2 - reliability class 2 (unacknowledged GTP, acknowledged LLC and RLC; protected data)
- 3 - reliability class 3 (unacknowledged GTP and LLC, acknowledged RLC; protected data)
- 4 - reliability class 4 (unacknowledged GTP,LLC and RLC; protected data)
- 5 - reliability class 5 (unacknowledged GTP,LLC and RLC; unprotected data)

<peak> is the peak data transfer throughput

- 0 - subscribed (default)
- 1 - up to 7,8 kbps
- 2 - up to 15,6 kbps
- 3 - up to 31,3 kbps
- 4 - up to 62,5 kbps
- 5 - up to 125 kbps
- 6 - up to 250 kbps
- 7 - up to 500 kbps
- 8 - up to 1000 kbps
- 9 - up to 2000 kbps

<mean> is the mean data transfer throughput

- 0 - subscribed (default)
- 1 - up to 0,8 kbph
- 2 - up to 1,6 kbps
- 3 - up to 3,9 kbps
- 4 - up to 7,8 kbps
- 5 - up to 15,6 kbps
- 6 - up to 39 kbps
- 7 - up to 78 kbps
- 8 - up to 156 kbps
- 9 - up to 390 kbps

- 10 - up to 7,6 Mbps
- 11 - up to 15.2 Mbps
- 12 - up to 38.2 Mbps
- 13 - up to 76.3 Mbps
- 14 - up to 152 Mbps
- 15 - up to 381 Mbps
- 16 - up to 762 Mbps
- 17 - up to 1525 Mbps
- 18 - up to 3815 Mbps
- 31 - Best Effort

- wait for response:

Response	Reason	Action
OK	Context parameters have been successfully stored	proceed ahead
ERROR	some error occurred	Check parameters and retry.



NOTE: If your minimum requirements are too high, then it can happen that it is impossible to establish a GPRS connection, because the network has not enough resources to guarantee that quality of service. If does this happen, then you shall try reducing your minimum quality requirements.

For example:

1- Let's assume you want to set-up the GPRS context number 1(cid) written before with your GPRS min QoS parameters:

precedence class: Normal priority

delay class: subscribed

reliability class: subscribed

peak throughput: not less than 15,6 kbps

mean throughput: not less than 7,8 kbps

command:

AT+CGQMIN= 1,2,0,0,5,4 <cr>

response

OK

4.2.3 Requested Quality of the Service

The requested quality of service parameters represents the connection quality that is requested to the network on GPRS context activation.

- send command

**AT+CGQREQ=<cid> , <precedence> , <delay> , <reliability> , <peak>
, <mean><cr>**

where:

<cid> is the index number of the desired context to be written (up to 5 different context).

<precedence> is the precedence class

<delay> is the delay class

<reliability> is the connection reliability class

<peak> is the peak data transfer throughput

<mean> is the mean data transfer throughput

as in the previous section.

- wait for response:

Response	Reason	Action
OK	Context parameters have been successfully stored	proceed ahead
ERROR	some error occurred	Check parameters and retry.

For example:

1- Let's assume you want to set-up the GPRS context number 1(cid) written before with your GPRS requested QoS parameters:

precedence class: High priority

delay class: subscribed

reliability class: subscribed

peak throughput: subscribed

mean throughput: best effort

command:

AT+CGQREQ= 1,1,0,0,0,31 <cr>

response

OK

4.3 GPRS context activation and data state entering

This operation corresponds to the dial and connect of a CSD GSM data call issued to an internet service provider.

- send command

ATD*99*<cid>#<cr>**

where:

<cid> is the index number of the desired context to be used (up to 5 different context).

- wait for response:

Response	Reason	Action
CONNECT	The GPRS connection is being processes	proceed ahead with the authentication & Packed data protocol
ERROR	some error occurred	Check context parameters and retry. See par. 4.2.1, 4.2.2, 4.2.3 Check also Network registration status. See par. 2.6.3
+CME ERROR: <error code>	some error occurred	Check context parameters and retry. See par. 4.2.1, 4.2.2, 4.2.3 Check also Network registration status. See par. 2.6.3

For example:

1- Let's assume you want to activate and enter the GPRS state with context number 1(cid) written before with your GPRS requested QoS parameters:

command:

```
ATD*99***1# <cr>
```

response

```
CONNECT
```

At this point, your application should start the PPP protocol with the LCP Exchange phase:

→ LCP Configure Request

← LCP Configure Acknowledge

→ PAP Authentication

← PAP-Ack

→ NCP (IP) Configure Request

← NCP (IP) Configure Acknowledge

At this point the TCP/IP - PPP protocol stack is up and data packets can be exchanged.

Explanation of TCP/IP and PPP protocol stack is beyond the scope of this document.

Further information on the LCP protocol and PPP protocol definition can be found in the RFC1661.

Further information on the PAP protocol definition can be found in the RFC1334.

Further information on the IPCP protocol definition can be found in the RFC1332.

4.4 GPRS data state exit

→ LCP Terminate Request

← LCP Terminate Acknowledge

- Wait for **NO CARRIER** response.

or alternatively:

- send escape sequence:
+++
- wait for 2s (default silence time)
- wait for response:

Response	Reason	Action
OK	Now TRIZIUM is in command mode	proceed ahead
ERROR	some error occurred	Check command syntax and timing and retry
NO CARRIER	Connection has been closed	Proceed ahead

- send command

ATH<cr>

- wait for response:

Response	Reason	Action
OK	The GPRS connection has been closed	
ERROR	some error occurred	Check command syntax and retry

4.5 Easy GPRS - HTTP client application

Let's suppose we want to connect our embedded device to an HTTP server and retrieve an html page using the EASY GPRS feature.

Initial data:

Server to be contacted: www.TRIZIUM.com

Application Layer Protocol: HTTP1.0 (RFC1945)

Page to be retrieved: homepage of server

GPRS settings:

APN: internet.gprs

IP of GPRS device: dynamically assigned by the network

DNS: assigned by the network

USERID: EASY GPRS

PASSWORD: EASY GPRS

Checking on the RFC990 the HTTP service we can find that the port 80 is dedicated for HTTP service, therefore our HTTP server will be waiting for incoming connections on that port and we will fix the EASY GPRS port to be contacted on the remote server exactly to 80.

Second thing we have to discover is whether the transport protocol has to be TCP or UDP; on the RFC1945 we can read that the HTTP Application layer protocol is meant to be on top of TCP/IP protocol, therefore the transport protocol choice will fall on TCP.

Now we have all the information needed to configure our system.

With our microcontroller we issue to the TRIZIUM the following AT commands:

<code>AT+CGDCONT = 1,"IP","internet.gprs","0.0.0.0",0,0<cr></code>	(1-GPRS context setting)
<code>AT#USERID = "EASY GPRS"<cr></code>	(2-Authentication setting)
<code>AT#PASSW = "EASY GPRS"<cr></code>	(2-Authentication setting)
<code>AT#SKTSET= 0,80," www.TRIZIUM.com"<cr></code>	(3-remote host setting)

For our convenience we store all these parameters with the command:

```
AT#SKTSAV<cr>
```

Now we can activate the GPRS connection and let the TRIZIUM module contact the server:

```
AT#SKTOP<cr>
```

When we receive the CONNECT indication, then we are exchanging data with the HTTP server program on the remote host machine.

Now following the HTTP protocol we ask for the homepage by sending the following lines on the serial line:

```
GET / HTTP/1.1<cr><lf>
Connection: keep-alive<cr><lf>
<cr><lf>
```



TIP: Remember that the strings, which are sent to the HTTP server, have to be ended by line feed character. To see the issued commands enable the local echo.

As a response to our query the HTTP server will reply with the HTML code of the homepage and some debugging responses that we will see directly on the serial line:

```
HTTP/1.1 200 OK
Date: Thu, 06 2003 10:21:58 GMT
Server: Apache/1.3.27 (Unix)
Last-Modified: Thu, 06 2003 10:21:58 GMT
Content-Type: text/html
Connection: close
```

```
<!DOCTYPE HTML PUBLIC "-//W3C//DTD HTML 3.2 FINAL//EN">
<HTML>
... here is all the HTML code of the page..
</HTML>
```

```
<pause>+++<pause>
```

NO CARRIER

Now the TRIZIUM is in command mode.

4.6 Easy GPRS - EMAIL sending application

Let's suppose we want to send with our embedded device an EMAIL by using a SMTP server.

Initial data:

Server to be contacted: smtp.domain.com

Application Layer Protocol: SMTP (RFC821)

Sender: "TRIZIUM"<TRIZIUM@telit.net>

Receiver: "Receiver"<receiver@domain.com>

Subject: Email Test

Message body: this message is sent for test Easy GPRS feature. Hello World!

GPRS settings:

APN: internet.gprs

IP of GPRS device: dynamically assigned by the network

DNS: assigned by the network

USERID: EASY GPRS

PASSWORD: EASY GPRS

Checking on the RFC990 the SMTP service we can find that the port 25 is dedicated for SMTP service, therefore our SMTP server will be waiting for incoming connections on that port and we will fix the EASY GPRS port to be contacted on the remote server exactly to 25.

Second thing we have to discover is whether the transport protocol has to be TCP or UDP; on the RFC821 we can read that the SMTP Application layer protocol is meant to be on top of TCP/IP protocol, therefore the transport protocol choice will fall on TCP.

Now we have all the information needed to configure our system.

With our microcontroller we issue to the TRIZIUM the following AT commands:

`AT+CGDCONT = 1,"IP","internet.gprs","0.0.0.0",0,0<cr>` (1-GPRS context setting)

`AT#USERID = "EASY GPRS" <cr>` (2-Authentication setting)

`AT#PASSW = "EASY GPRS" <cr>` (2-Authentication setting)

`AT#SKTSET= 0,25,"smtp.domain.com" <cr>` (3-remote host setting)

For our convenience we store all these parameters with the command:

`AT#SKTSAV<cr>`

Now we can activate the GPRS connection and let the TRIZIUM module contact the server:

`AT#SKTOP<cr>`

When we receive the CONNECT indication, then we are exchanging data with the SMTP server program on the remote host machine.

Now following the SMTP protocol we proceed with the HELO presentation and mail delivery directly over the serial line (in blu the data sent by us, in violet the one received from host):

220 smtp.domain.com ESMTP ; Thu, 5 Jun 2003 14:45:11 +0200

HELO my.domain.com<cr><lf>

250 smtp.domain.com Hello my.domain.com [111.111.111.127], pleased to meet you

MAIL FROM: "TRIZIUM"<TRIZIUM@telit.net><cr><lf>

250 2.1.0 "TRIZIUM"<TRIZIUM@telit.net>... Sender ok

RCPT TO: "Receiver"<receiver@domain.com><cr><lf>

250 2.1.5 "receiver@domain.com"... Recipient ok

DATA<cr><lf>

354 Enter mail, end with "." on a line by itself

From: "TRIZIUM"<TRIZIUM@telit.net><cr><lf>

To: "Receiver"<receiver@domain.com><cr><lf>

Subject: Email Test<cr><lf>

this message is sent for testing Easy GPRS feature. Hello World!<cr><lf>

.<cr><lf>

250 2.0.0 h55CjBVI020859 Message accepted for delivery

QUIT<cr><lf>

221 2.0.0 smtp.domain.com closing connection

<pause>+++<pause>

NO CARRIER

Now the TRIZIUM is in command mode.

5 EASY CAMERA OPERATIONS

5.1 Easy Camera - Send photo via EMAIL

Let's suppose we want to send, with our embedded device, a taken photo via EMAIL by using a SMTP server.

Initial data:

Server to be contacted: smtp.domain.com

Application Layer Protocol: SMTP (RFC821)

Sender: "TRIZIUM" <TRIZIUM@telit.net>

Receiver: "Receiver" <receiver@domain.com>

Subject: Email Test

Message body: this message is sent for test Easy CAMERA feature. Hello World!

GPRS settings:

APN: internet.gprs

IP of GPRS device: dynamically assigned by the network

DNS: assigned by the network

USERID: EASY GPRS

PASSWORD: EASY GPRS

SMTP settings:

USERID: SMTP USER

PASSWORD: SMTP PASSW

Now we have all the information needed to configure our system.

With our microcontroller we issue to the TRIZIUM the following AT commands:

<code>AT+CGDCONT=1,"IP","internet.gprs","0.0.0.0",0,0<cr></code>	(1-GPRS context setting)
<code>AT#USERID = "EASY GPRS"<cr></code>	(2-Authentication setting)
<code>AT#PASSW = "EASY GPRS"<cr></code>	(3-Authentication setting)
<code>AT#ESMTP = "smtp.domain.com"<cr></code>	(4-SMTP server setting)
<code>AT#EUSER = "SMTP USER"<cr></code>	(5-Authentication setting)
<code>AT#EPASSW = "SMTP PASSW"<cr></code>	(6-Authentication setting)
<code>AT#EADDR= "TRIZIUM@telit.net"<cr></code>	(7-Sender address setting)



NOTE: Authentication settings could be different between GPRS and SMTP. This is due to the fact that in the GPRS authentication it is requested user and password of your internet provider, instead of the SMTP authentication where user and password is used to connect to the SMTP server.

Now we can take the photo, we want to send via EMAIL:

`AT#CAMON<cr>`

(turn on the camera)

`AT#TPHOTO<cr>`

(take photo)

`AT#CAMOFF<cr>`

(turn off the camera)

After receiving the OK indication, we are finally able to attach the photo and send it.

`AT#SEMAIL="receiver@domain.com", "Email test", 1`

➤ this message is sent for test the Easy CAMERA feature. Hello World!

`CTRL-Z`

The email has been sent with our photo.

In order to download directly the photo from the module:

`AT#RPHOTO<cr>`

(read photo)

... here all the binary digits of the photo are sent.

And the command terminates with the result code OK.

In order to store correctly the picture, the last `<cr><lf>OK<cr><lf>` digits must not be included into the image ipg file.



TIP: Remember that the JPG image always starts with 0xFF 0xD8 and ends with 0xFF 0xD9, but these digits can appear also inside the image file.



NOTE: In order to download the photo from the module with the command AT#RPHOTO it is necessary to fix the baudrate to 115200 (AT+IPR=115200) and use the hardware flow control (CTS and RTS).

6 Document Change Log

Revision	Date	Changes
ISSUE #1	18/10/02	First release
ISSUE #2	08/07/05	Updated par. 2.2 Turning Off TRIZIUM Added par.2.3 Hardware Unconditional Reboot